



AWex
NARZĘDZIA

Produkcja narzędzi specjalnych dla przemysłu i motoryzacji

KATALOG 2024



**TWOJE POTRZEBY
NASZE NARZĘDZIA**

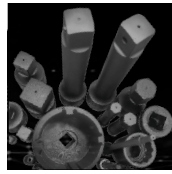

01 Nasadki udarowe

Nasadki udarowe kwadrat 1/4"

Nasadki kwadrat 1/4" - 6-kątne hexagon	6
Nasadki kwadrat 1/4" - 6-kątne hexagon/ magnes	6
Nasadki kwadrat 1/4" - 6-kątne hexagon/ ekstra wytrzymałość	6
Nasadki kwadrat 1/4" - 6-kątne hexagon/ ekstra wytrzymałość / magnes	6
Nasadki kwadrat 1/4" - 6-kątne hexagon/ dłuższa wersja	6
Nasadki kwadrat 1/4" - 6-kątne hexagon/ dłuższa wersja / magnes sprężyn.	6
Nasadki kwadrat 1/4" - 12-kątne double hexagon	7
Nasadki kwadrat 1/4" - 12-kątne double hexagon/ magnes	7
Nasadki kwadrat 1/4" - 12-kątne double hexagon/ ekstra wytrzymałość	7
Nasadki kwadrat 1/4" - 12-kątne double hexagon/ ekstra wytrzymałość /magnes	7
Nasadki kwadrat 1/4" - 12-kątne double hexagon/ dłuższa wersja	7
Nasadki kwadrat 1/4" - 12-kątne double hexagon/ dłuższa wersja/magnes spręż.	7
Nasadki kwadrat 1/4" - TORX® socket screws	8
Nasadki kwadrat 1/4" - TORX® socket screws/ magnes	8
Nasadki kwadrat 1/4" - TORX® PLUS surface drive	8
Nasadki kwadrat 1/4" - TORX® PLUS surface drive/ magnes	8

Nasadki udarowe kwadrat 3/8"

Nasadki kwadrat 3/8" - 6-kątne hexagon / krótsza wersja	9
Nasadki kwadrat 3/8" - 6-kątne hexagon/ krótsza wersja / magnes	9
Nasadki kwadrat 3/8" - 6-kątne hexagon	9
Nasadki kwadrat 3/8" - 6-kątne hexagon / dłuższa wersja	10
Nasadki kwadrat 3/8" - 6-kątne hexagon/ dłuższa wersja / magnes sprężyn.	10
Nasadki kwadrat 3/8" - 12-kątne double hexagon / krótsza wersja	10
Nasadki kwadrat 3/8" - 12-kątne double hexagon/ krótsza wersja / magnes	10
Nasadki kwadrat 3/8" - 12-kątne double hexagon	11
Nasadki kwadrat 3/8" - 12-kątne double hexagon/ dłuższa wersja	11
Nasadki kwadrat 3/8" - 12-kątne double hexagon/ dłuższa wersja/ magnes spręż.	11
Nasadki kwadrat 3/8" - TORX® PLUS surface drive	12
Nasadki kwadrat 3/8" - TORX® PLUS surface drive/ magnes	12
Nasadki kwadrat 3/8" - TORX® socket screws	12
Nasadki kwadrat 3/8" - TORX® socket screws/ magnes	12
Nasadki kwadrat 3/8" - 6-kątne hexagon / krótsza wersja / cienkościenne	13
Nasadki kwadrat 3/8" - 6-kątne hexagon / dłuższa wersja / cienkościenne	13
Nasadki kwadrat 3/8" - 12-kątne double hexagon / krótsza wersja / cienkościenne	14
Nasadki kwadrat 3/8" - 12-kątne double hexagon / dłuższa wersja / cienkościenne	14
Nasadki kwadrat 3/8" - 6-kątne hexagon / fast lead	14
Nasadki kwadrat 3/8" - TORX® PLUS surface drive/ cienkościenne	15
Nasadki kwadrat 3/8" - TORX® PLUS surface drive/dłuższa wersja /cienkościen.	15
Nasadki kwadrat 3/8" - TORX® PLUS socket screw / wkrętakowe	15
Nasadki kwadrat 3/8" - 6-kątne hexagon / wkrętakowe	16
Nasadki kwadrat 3/8" - XZN / wkrętakowe	16
Końcówki imbusowe 7/16" - 11 mm	16
Adaptery kwadrat 3/8" - 6-kątne hexagon 7/16" - 11 mm	16

Nasadki udarowe kwadrat 1/2"

Nasadki kwadrat 1/2" - 6-kątne hexagon / krótsza wersja	17
Nasadki kwadrat 1/2" - 6-kątne hexagon/ krótsza wersja / magnes	17
Nasadki kwadrat 1/2" - 6-kątne hexagon / półdługa wersja	17
Nasadki kwadrat 1/2" - 6-kątne hexagon / dłuższa wersja	17
Nasadki kwadrat 1/2" - 12-kątne double hexagon / krótsza wersja	18
Nasadki kwadrat 1/2" - 12-kątne double hexagon/ krótsza wersja / magnes	18
Nasadki kwadrat 1/2" - 12-kątne double hexagon / półdługa wersja	19
Nasadki kwadrat 1/2" - 12-kątne double hexagon / dłuższa wersja	19
Nasadki kwadrat 1/2" - TORX® socket screws	19
Nasadki kwadrat 1/2" - TORX® socket screws/ magnes	19
Nasadki kwadrat 1/2" - TORX® socket screws/ dłuższa wersja	20
Nasadki kwadrat 1/2" - TORX® PLUS surface drive	20
Nasadki kwadrat 1/2" - TORX® PLUS surface drive / dłuższa wersja	20
Nasadki kwadrat 1/2" - 6-kątne hexagon / fast lead	21
Nasadki kwadrat 1/2" - kwadrat	21
Nasadki kwadrat 1/2" - 6-kątne hexagon / krótsza wersja / cienkościenne	22
Nasadki kwadrat 1/2" - 6-kątne hexagon / dłuższa wersja / cienkościenne	22
Nasadki kwadrat 1/2" - 12-kątne double hexagon / krótsza wersja / cienkościen.	23

5	Nasadki kwadrat 1/2" - 12-kątne double hexagon / dłuższa wersja / cienkościen.	23
6	Nasadki kwadrat 1/2" - TORX® PLUS surface drive/ cienkościenne	24
6	Nasadki kwadrat 1/2" - TORX® PLUS surface drive/dłuższa wersja /cienkościen.	24
6	Nasadki kwadrat 1/2" - TORX® PLUS / wkrętakowe	25
6	Nasadki kwadrat 1/2" - 6-kątne hexagon / wkrętakowe	25
6	Nasadki kwadrat 1/2" - XZN / wkrętakowe	25
6	Końcówki imbusowe 7/16" - 11 mm	26
6	Adaptery kwadrat 1/2" - 6-kątne hexagon 7/16" - 11 mm	26

Nasadki udarowe kwadrat 3/4"

26	Nasadki kwadrat 3/4" - 6-kątne hexagon / krótsza wersja	26
27	Nasadki kwadrat 3/4" - 6-kątne hexagon / dłuższa wersja	27
27	Nasadki kwadrat 3/4" - 6-kątne hexagon / dłuższa wersja XL	27
27	Nasadki kwadrat 3/4" - 6-kątne hexagon / dłuższa wersja / cienkościenne	27
28	Nasadki kwadrat 3/4" - 12-kątne double hexagon / krótsza wersja	28
29	Nasadki kwadrat 3/4" - 12-kątne double hexagon / dłuższa wersja	29
29	Nasadki kwadrat 3/4" - 12-kątne double hexagon / dłuższa wersja XL	29
29	Nasadki kwadrat 3/4" - 12-kątne double hexagon / dłuższa wersja / cienkościen.	29
30	Końcówki imbusowe 16 mm	30
30	Adaptery kwadrat 3/4" - 6-kątne hexagon 16 mm	30

Nasadki udarowe kwadrat 1"

30	Nasadki kwadrat 1" - 6-kątne hexagon / krótsza wersja	30
31	Nasadki kwadrat 1" - 6-kątne hexagon / dłuższa wersja	31
31	Nasadki kwadrat 1" - 6-kątne hexagon / dłuższa wersja XL	31
31	Nasadki kwadrat 1" - 6-kątne hexagon / dłuższa wersja / cienkościenne	31
32	Nasadki kwadrat 1" - 12-kątne double hexagon / krótsza wersja	32
33	Nasadki kwadrat 1" - 12-kątne double hexagon / dłuższa wersja	33
33	Nasadki kwadrat 1" - 12-kątne double hexagon / dłuższa wersja XL	33
33	Nasadki kwadrat 1" - 12-kątne double hexagon / dłuższa wersja / cienkościen.	33
34	Nasadki kwadrat 1" - kwadrat	34
34	Nasadki kwadrat 1" - 6-kątne hexagon / wkrętakowe	34
34	Końcówki imbusowe 22 mm	34
34	Adaptery kwadrat 1" - 6-kątne hexagon 11 mm	34

Nasadki udarowe kwadrat 1 1/2"

35	Nasadki kwadrat 1 1/2" - 6-kątne hexagon / krótsza wersja	35
35	Nasadki kwadrat 1 1/2" - 6-kątne hexagon / dłuższa wersja	35
36	Nasadki kwadrat 1 1/2" - 12-kątne double hexagon / krótsza wersja	36
36	Nasadki kwadrat 1 1/2" - 12-kątne double hexagon / dłuższa wersja	36
37	Nasadki kwadrat 1 1/2" - 6-kątne hexagon / wkrętakowe	37

Nasadki udarowe kwadrat 2 1/2"

37	Nasadki kwadrat 2 1/2" - 6-kątne hexagon / krótsza wersja	37
38	Nasadki kwadrat 2 1/2" - 12-kątne double hexagon / krótsza wersja	38

02 Klucze nasadowe

Klucze nasadowe G7

40	Klucze nasadowe G7 - 6-kątne hexagon	40
40	Klucze nasadowe G7 - 6-kątne hexagon / magnes	40
40	Klucze nasadowe G7 - 12-kątne double hexagon	40
40	Klucze nasadowe G7 - 12-kątne double hexagon / magnes	40

Klucze nasadowe 6-kątne 1/4"

41	Klucze nasadowe 6-kątne 1/4" - 6-kątne hexagon / krótsza wersja	41
41	Klucze nasadowe 6-kątne 1/4" - 6-kątne hexagon / krótsza wersja / magnes	41
41	Klucze nasadowe 6-kątne 1/4" - 6-kątne hexagon / dłuższa wersja	41
41	Klucze nasadowe 6-kątne 1/4" - 6-kątne hexagon / dłuższa wersja / magnes	41
42	Klucze nasadowe 6-kątne 1/4" - 12-kątne double hexagon / krótsza wersja	42
42	Klucze nasadowe 6-kątne 1/4" - 12-kątne double hexagon/krótsza wersja/magn.	42
42	Klucze nasadowe 6-kątne 1/4" - 12-kątne double hexagon / dłuższa wersja	42
42	Klucze nasadowe 6-kątne 1/4" - 12-kątne double hexagon /dłuższa wersja/magn.	42
42	Klucze nasadowe 6-kątne 1/4" - TORX® socket screws	42

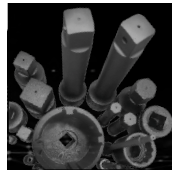

03 Łączniki, przedłużki do kluczy

43

Łączniki do kluczy 6-kątne 1/4"

44

Łączniki do kluczy 6-kątne 1/4" - kwadrat / krótsza wersja / kotek sprężyn.	44
Łączniki do kluczy 6-kątne 1/4" - kwadrat / dłuższa wersja / kotek sprężyn.	44
Łączniki do kluczy 6-kątne 1/4" - kwadrat / dłuższa wersja / otwór przelotowy	44
Łączniki do kluczy 6-kątne 1/4" - kwadrat / dłuższa wersja / kulka	45
Łączniki do kluczy 6-kątne 1/4" - kwadrat / dłuższa wersja / kulka / szybkozłącz.	45

Łączniki do kluczy 6-kątne 5/16"

45

Łączniki do kluczy 6-kątne 5/16" - kwadrat / krótsza wersja / kotek sprężyn.	45
--	----

Łączniki do kluczy 6-kątne 7/16"

45

Łączniki do kluczy 6-kątne 7/16" - kwadrat / krótsza wersja / kulka / szybkozłącz.	45
Łączniki do kluczy 6-kątne 7/16" - kwadrat / dłuższa wersja / kotek sprężyn.	46

Łączniki do kluczy G7

46

Łączniki do kluczy G7 - kwadrat / dłuższa wersja / kotek sprężynowy	46
---	----

Łączniki, przedłużki do kluczy kwadrat 1/4"

46

Łączniki do kluczy kwadrat 1/4" - kwadrat / krótsza wersja / kotek sprężyn.	46
Przedłużki do kluczy kwadrat 1/4" - kwadrat / dłuższa wersja / kotek sprężyn.	46
Przedłużki do kluczy kwadrat 1/4" - kwadrat / dłuższa wersja / kulka	47
Łączniki do kluczy kwadrat 1/4" - kwadrat / krótsza wersja / kulka / szybkozłącz.	47

Łączniki, przedłużki do kluczy kwadrat 3/8"

47

Łączniki do kluczy kwadrat 3/8" - kwadrat / krótsza wersja / kotek sprężyn.	47
Przedłużki do kluczy kwadrat 3/8" - kwadrat / dłuższa wersja / kotek sprężyn.	47
Przedłużki do kluczy kwadrat 3/8" - kwadrat / dłuższa wersja / kulka	48
Łączniki do kluczy kwadrat 3/8" - kwadrat / kulka / szybkozłącz.	48

Łączniki, przedłużki do kluczy kwadrat 1/2"

48

Łączniki do kluczy kwadrat 1/2" - kwadrat / krótsza wersja / kotek sprężyn.	48
Przedłużki do kluczy kwadrat 1/2" - kwadrat / dłuższa wersja / kotek sprężyn.	48
Łączniki do kluczy kwadrat 1/2" - kwadrat / krótsza wersja / otwór przelotowy	49
Łączniki do kluczy kwadrat 1/2" - kwadrat / krótsza wersja / kulka / szybkozłącz.	49
Przedłużki do kluczy kwadrat 1/2" - kwadrat / dłuższa wersja / kulka	49

Łączniki, przedłużki do kluczy kwadrat 5/8"

49

Łączniki do kluczy kwadrat 5/8" - kwadrat / krótsza wersja / kotek sprężynowy	49
Łączniki do kluczy kwadrat 5/8" - kwadrat / krótsza wersja / otwór przelotowy	50

Łączniki, przedłużki do kluczy kwadrat 3/4"

50

Łączniki do kluczy kwadrat 3/4" - kwadrat / krótsza wersja / kotek sprężynowy	50
Łączniki do kluczy kwadrat 3/4" - kwadrat / krótsza wersja / otwór przelotowy	50
Przedłużki do kluczy kwadrat 3/4" - kwadrat / dłuższa wersja / otwór przelotowy	50
Łączniki do kluczy kwadrat 3/4" - kwadrat / krótsza wersja / kulka / szybkozłącz.	51

Łączniki, przedłużki do kluczy kwadrat 1"

51

Łączniki do kluczy kwadrat 1" - kwadrat / krótsza wersja / kotek sprężynowy	51
Łączniki do kluczy kwadrat 1" - kwadrat / krótsza wersja / otwór przelotowy	51
Przedłużki do kluczy kwadrat 1" - kwadrat / dłuższa wersja / otwór przelotowy	51
Łączniki do kluczy kwadrat 3/4" - kwadrat / krótsza wersja / kulka / szybkozłącz.	52

Łączniki, przedłużki do kluczy kwadrat 1 1/2"

52

Łączniki do kluczy kwadrat 1 1/2" - kwadrat / krótsza wersja / otwór przelotowy	52
Przedłużki do kluczy kwadrat 1 1/2" - kwadrat / dłuższa wersja / otwór przelotowy	52

Łączniki, przedłużki do kluczy kwadrat 1 1/2"

53

Łączniki do kluczy kwadrat 2 1/2" - kwadrat / krótsza wersja / otwór przelotowy	53
Przedłużki do kluczy kwadrat 2 1/2" - kwadrat / dłuższa wersja / otwór przelotowy	53

04 Pokrętła typ -L

54

Pokrętła z uchwytem radetkowanym lub gładkim

55

Pokrętła 3/8"	55
Pokrętła 1/2"	55
Pokrętła 3/4"	55
Pokrętła 1"	55

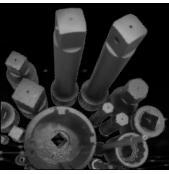

Specjalizujemy się w produkcji narzędzi specjalnych według indywidualnego zapotrzebowania klienta.

Nasze rozwiązania są skrojone na miarę, aby sprostać najbardziej wymagającym potrzebom i zapewnić najwyższą jakość i funkcjonalność. Niezależnie od branży, w której działasz, rozumiemy, że unikalne wyzwania wymagają unikalnych narzędzi.

>> nasadki, klucze, bity, redukcje

>> imbusy, pokrętła, przedłużki



Dlaczego warto z nami współpracować?

TWÓJ POMYSŁ NASZE NASADKI

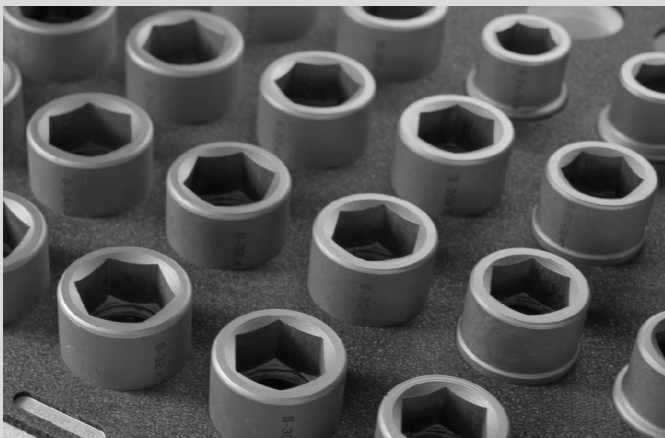

>> Indywidualne podejście

Zaczynamy od zrozumienia Twoich konkretnych potrzeb. Dzięki temu możemy dostosować nasze narzędzia do Twojego indywidualnego zapotrzebowania.

>> Innowacja

Stale doskonalimy nasze procesy, aby spełniać najwyższe standardy jakości. Niezależnie od skomplikowanych wymagań, jesteśmy gotowi podjąć wyzwanie i stworzyć dla Ciebie narzędzia, które przyspieszą Twoje procesy i poprawią wydajność.

>> Jakość i trwałość

Rozumiemy, że narzędzia specjalne muszą być nie tylko precyzyjne, ale również trwałe, aby przetrwać wymagające warunki pracy. Dlatego przykładamy dużą wagę do jakości wykonania i używamy tylko najlepszych materiałów.

>> Szybka realizacja zamówień

Jesteśmy świadomi, że czas jest cenny, dlatego zawsze dążymy do terminowego dostarczenia zamówionych narzędzi. Nasz zespół składa się z profesjonalistów, którzy pracują sprawnie i efektywnie, aby zapewnić, że otrzymasz swoje narzędzia na czas.

>> Obsługa klienta

Naszym priorytetem jest satysfakcja klienta. Nasz zespół obsługi klienta jest zawsze gotów odpowiedzieć na Twoje pytania, zapewnić wsparcie techniczne i dostarczyć Ci niezbędne informacje. Jesteśmy tutaj, aby Ci pomóc na każdym etapie procesu.

TWOJE POTRZEBY NASZE KLUCZE

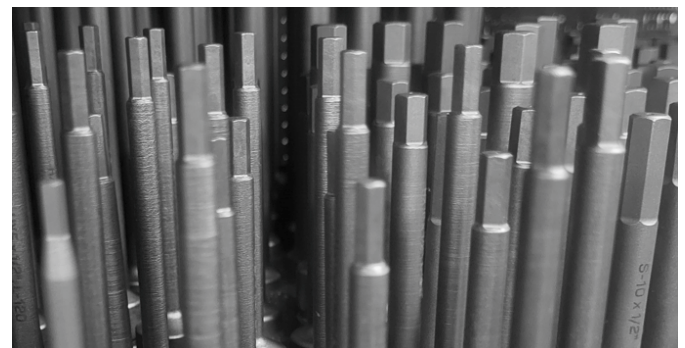

Nasadki udarowe są dostępne w różnych rozmiarach, kształtach i typach, co pozwala dopasować je do szerokiej gamy zastosowań

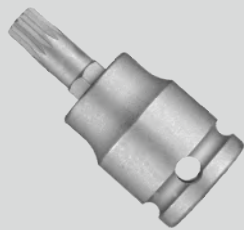

Potrzebujesz indywidualnych rozwiązań?
Zapraszamy do kontaktu.

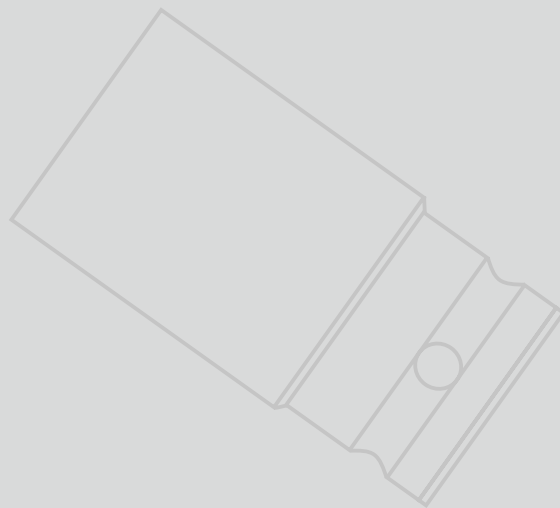
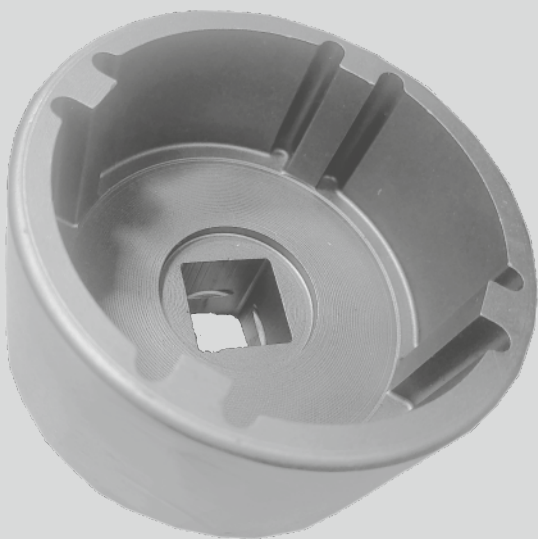

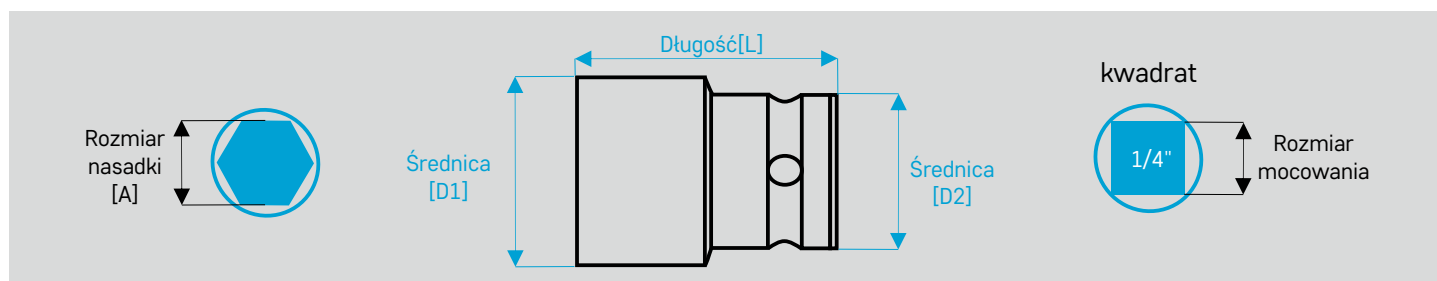

Nasadki udarowe 6-kątne hexagon



Nasadki udarowe 6-kątne hexagon z magnesem

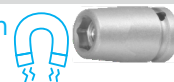

Kod	A [mm]	L [mm]	D1 [mm]	D2 [mm]
01-1/4-011	3,5	23	7,0	13
01-1/4-012	4,0	23	7,6	13
01-1/4-013	4,5	23	8,2	13
01-1/4-014	5,0	23	8,8	13
01-1/4-015	5,5	23	9,5	13
01-1/4-016	6,0	23	10,0	13
01-1/4-017	7,0	23	11,3	13
01-1/4-018	8,0	23	12,5	13
01-1/4-019	9,0	23	13,8	13
01-1/4-020	10,0	23	15,0	13
01-1/4-021	11,0	23	16,3	13
01-1/4-022	12,0	23	17,0	13
01-1/4-023	13,0	23	18,8	13
01-1/4-024	14,0	23	20,0	13
01-1/4-025	1/4"	23	10,3	13
01-1/4-026	5/16"	23	12,5	13
01-1/4-027	3/8"	23	15,0	13
01-1/4-028	1/2"	23	18,8	13

Kod	A [mm]	L [mm]	D1 [mm]	D2 [mm]
01-1/4-049	5,0	23	8,8	13
01-1/4-050	5,5	23	9,5	13
01-1/4-051	6,0	23	10,0	13
01-1/4-052	7,0	23	11,3	13
01-1/4-053	8,0	23	12,5	13
01-1/4-054	9,0	23	13,8	13
01-1/4-055	10,0	23	15,0	13
01-1/4-056	11,0	23	16,3	13
01-1/4-057	13,0	23	18,8	13
01-1/4-058	1/4"	23	10,3	13
01-1/4-059	5/16"	23	12,5	13
01-1/4-060	3/8"	23	15,0	13
01-1/4-061	1/2"	23	18,8	13

Nasadki udarowe 6-kątne hexagon



ekstra
wytrzymałość

Kod	A [mm]	L [mm]	D1 [mm]	D2 [mm]
01-1/4-082	5,5	23	9,5	13
01-1/4-083	6,0	23	10,0	13
01-1/4-084	7,0	23	11,3	13
01-1/4-085	8,0	23	12,5	13
01-1/4-086	9,0	23	13,8	13
01-1/4-087	10,0	23	15,0	13

Nasadki udarowe 6-kątne hexagon z magnesem



ekstra
wytrzymałość

Kod	A [mm]	L [mm]	D1 [mm]	D2 [mm]
01-1/4-108	5,5	23	10,0	13
01-1/4-109	6,0	23	11,3	13
01-1/4-110	7,0	23	12,5	13
01-1/4-111	8,0	23	13,8	13
01-1/4-112	9,0	23	15,0	13
01-1/4-113	10,0	23	16,3	13

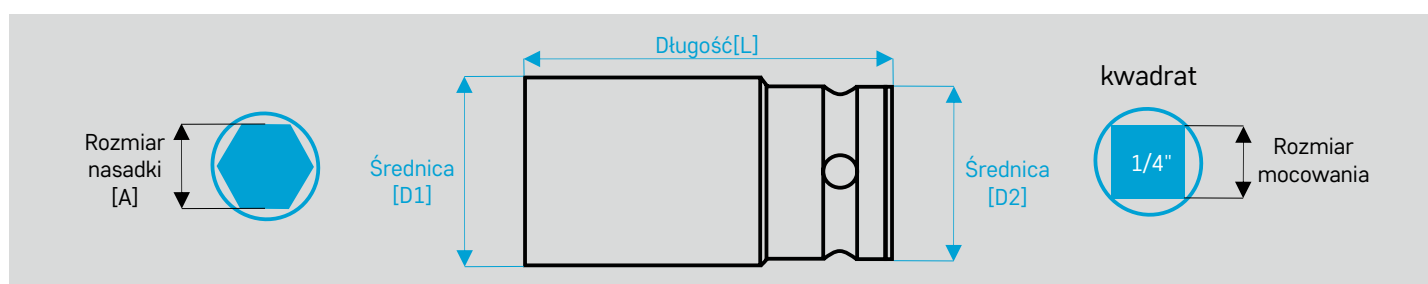

Nasadki udarowe 6-kątne hexagon - dłuższa wersja



Nasadki udarowe 6-kątne hexagon - dłuższa wersja z magnesem sprężynowym



Kod	A [mm]	L [mm]	D1 [mm]	D2 [mm]
01-1/4-124	7,0	50	11,3	13
01-1/4-125	8,0	50	12,5	13
01-1/4-126	9,0	50	13,8	13
01-1/4-127	10,0	50	15,0	13
01-1/4-128	11,0	50	16,3	13
01-1/4-129	12,0	50	17,0	13
01-1/4-130	13,0	50	18,8	13

Kod	A [mm]	L [mm]	D1 [mm]	D2 [mm]
01-1/4-151	7,0	50	11,3	13,0
01-1/4-152	8,0	50	12,5	13,0
01-1/4-153	10,0	50	15,0	13,0
01-1/4-154	13,0	50	18,8	13,0

Potrzebujesz czegoś więcej? Dla nas to żaden problem!

6 Możemy wyprodukować narzędzia specjalne dostosowane do Twoich indywidualnych potrzeb.

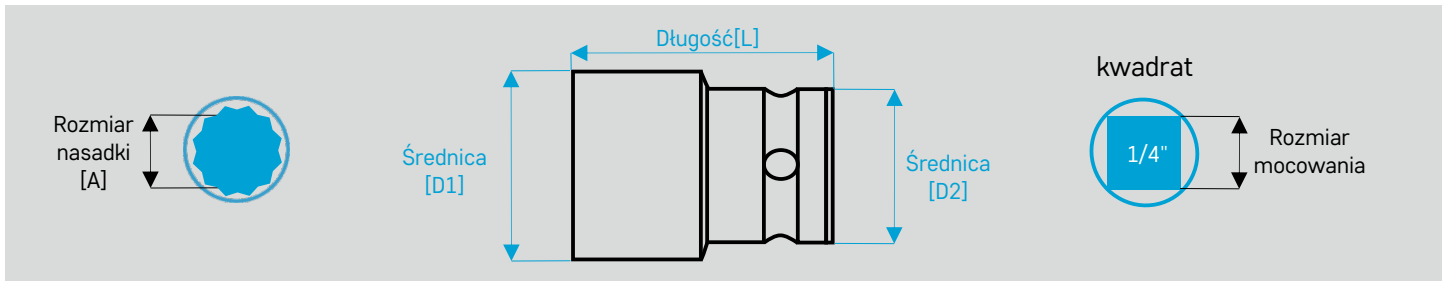

Nasadki udarowe 12-kątne double hexagon



Nasadki udarowe 12-kątne double hexagon z magnesem



Kod	A [mm]	L [mm]	D1 [mm]	D2 [mm]
01-1/4-175	3,5	23	7,0	13
01-1/4-176	4,0	23	7,6	13
01-1/4-177	4,5	23	8,2	13
01-1/4-178	5,0	23	8,8	13
01-1/4-179	5,5	23	9,5	13
01-1/4-180	6,0	23	10,0	13
01-1/4-181	7,0	23	11,3	13
01-1/4-182	8,0	23	12,5	13
01-1/4-183	9,0	23	13,8	13
01-1/4-184	10,0	23	15,0	13
01-1/4-185	11,0	23	16,3	13
01-1/4-186	12,0	23	17,0	13
01-1/4-187	13,0	23	18,8	13
01-1/4-188	14,0	23	20,0	13
01-1/4-189	1/4"	23	10,3	13
01-1/4-190	5/16"	23	12,5	13
01-1/4-191	3/8"	23	15,0	13
01-1/4-192	1/2"	23	18,8	13

Kod	A [mm]	L [mm]	D1 [mm]	D2 [mm]
01-1/4-213	5,0	23	8,8	13
01-1/4-214	5,5	23	9,5	13
01-1/4-215	6,0	23	10,0	13
01-1/4-216	7,0	23	11,3	13
01-1/4-217	8,0	23	12,5	13
01-1/4-218	9,0	23	13,8	13
01-1/4-219	10,0	23	15,0	13
01-1/4-220	11,0	23	16,3	13
01-1/4-221	13,0	23	18,8	13
01-1/4-222	1/4"	23	10,3	13
01-1/4-223	5/16"	23	12,5	13
01-1/4-224	3/8"	23	15,0	13
01-1/4-225	1/2"	23	18,8	13

Nasadki udarowe 12-kątne double hexagon ekstra wytrzymałość



Kod	A [mm]	L [mm]	D1 [mm]	D2 [mm]
01-1/4-246	5,5	23	9,5	13
01-1/4-247	6,0	23	10,0	13
01-1/4-248	7,0	23	11,3	13
01-1/4-249	8,0	23	12,5	13
01-1/4-250	9,0	23	13,8	13
01-1/4-251	10,0	23	15,0	13

Nasadki udarowe 12-kątne double hexagon z magnesem ekstra wytrzymałość



Kod	A [mm]	L [mm]	D1 [mm]	D2 [mm]
01-1/4-272	5,5	23	10,0	13
01-1/4-273	6,0	23	11,3	13
01-1/4-274	7,0	23	12,5	13
01-1/4-275	8,0	23	13,8	13
01-1/4-276	9,0	23	15,0	13
01-1/4-277	10,0	23	16,3	13

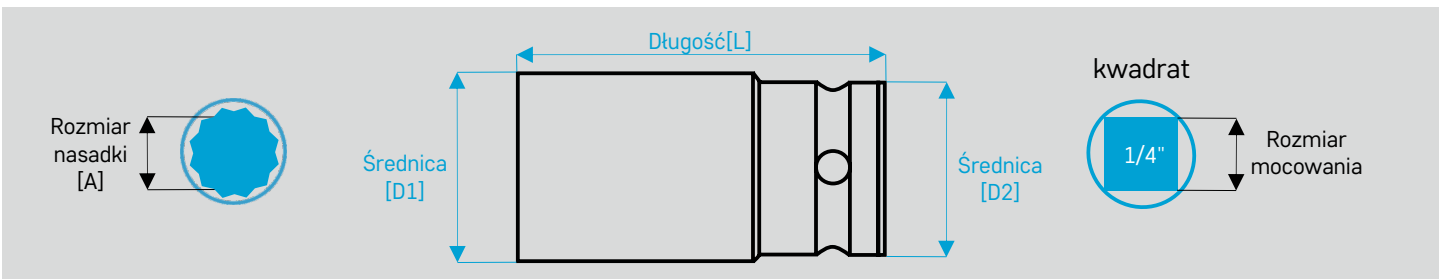

Nasadki udarowe 12-kątne double hexagon - dłuższa wersja



Kod	A [mm]	L [mm]	D1 [mm]	D2 [mm]
01-1/4-298	7,0	50	11,3	13
01-1/4-299	8,0	50	12,5	13
01-1/4-300	9,0	50	13,8	13
01-1/4-301	10,0	50	15,0	13
01-1/4-302	11,0	50	16,3	13
01-1/4-303	12,0	50	17,0	13
01-1/4-304	13,0	50	18,8	13

Nasadki udarowe 12-kątne double hexagon - dłuższa wersja z magnesem sprężynowym



Kod	A [mm]	L [mm]	D1 [mm]	D2 [mm]
01-1/4-325	7,0	50	11,3	13,0
01-1/4-326	8,0	50	12,5	13,0
01-1/4-327	10,0	50	15,0	13,0
01-1/4-328	13,0	50	18,8	13,0

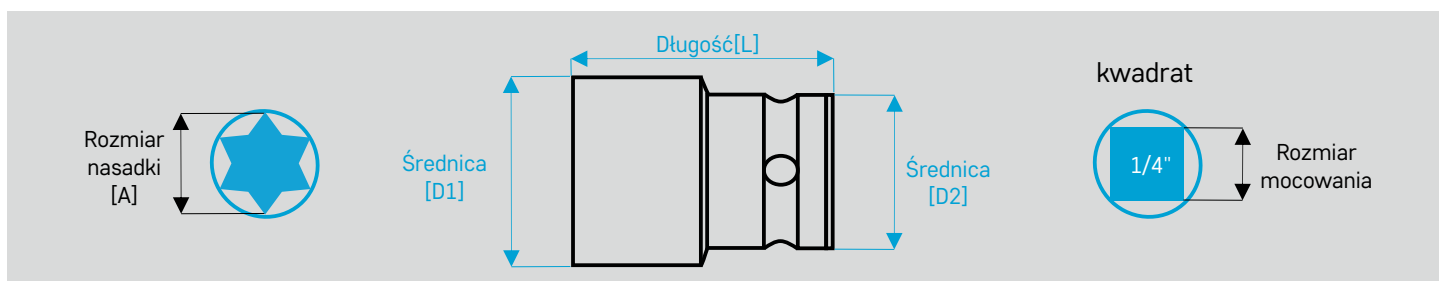

Nasadki udarowe TORX®
socket screws



Kod	A [mm]	L [mm]	D1 [mm]	D2 [mm]
01-1/4-349	E4	25	6,5	13
01-1/4-350	E5	25	7,5	13
01-1/4-351	E6	25	8,5	13
01-1/4-352	E7	25	9,0	13
01-1/4-353	E8	25	9,8	13
01-1/4-354	E10	25	12,0	13
01-1/4-355	E12	25	14,0	13

Nasadki udarowe TORX®
socket screws z magnesem



Kod	A [mm]	L [mm]	D1 [mm]	D2 [mm]
01-1/4-376	E6	25	8,5	13
01-1/4-377	E8	25	9,8	13
01-1/4-378	E10	25	12,0	13
01-1/4-379	E12	25	14,0	13

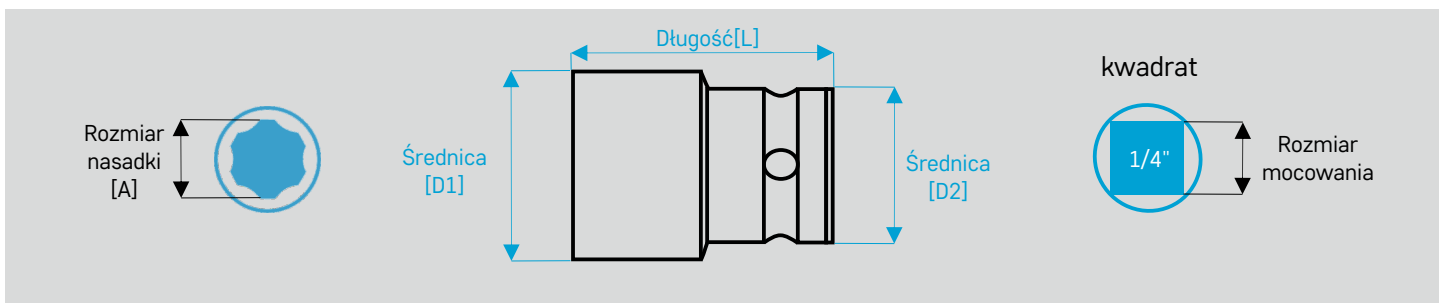

Nasadki udarowe 6-kątne hexagon Surface Drive
TORX® PLUS



Kod	A [mm]	L [mm]	D1 [mm]	D2 [mm]
01-1/4-400	7,0	23	11,3	13
01-1/4-401	8,0	23	12,5	13
01-1/4-402	10,0	23	15,0	13
01-1/4-403	11,0	23	16,3	13
01-1/4-404	13,0	23	18,8	13

Nasadki udarowe 6-kątne hexagon Surface Drive
TORX® PLUS z magnesem



Kod	A [mm]	L [mm]	D1 [mm]	D2 [mm]
01-1/4-425	7,0	23	11,3	13
01-1/4-426	8,0	23	12,5	13
01-1/4-427	10,0	23	15,0	13
01-1/4-428	13,0	23	18,8	13



POLSKA PRODUKCJA
SOLIDNE WYKONANIE
 TO WYDAJNOŚĆ TWOJEJ PRACY

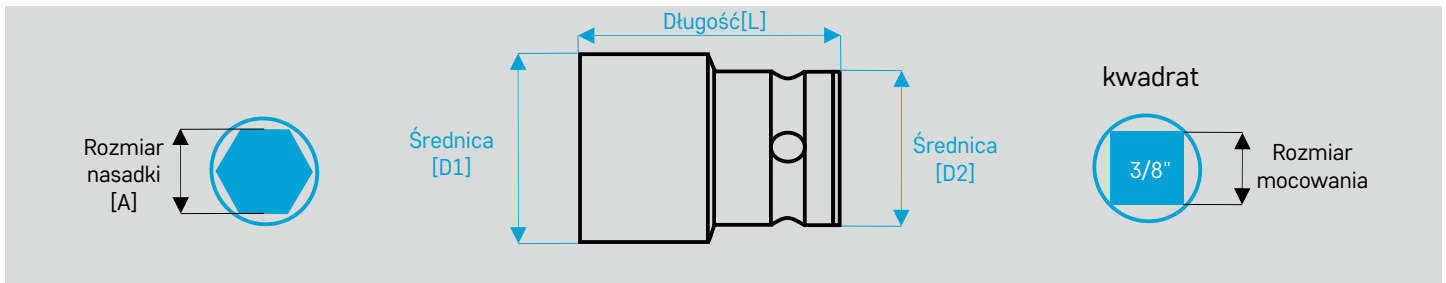

Nasadki udarowe 6-kątne hexagon - krótka wersja



Kod	A [mm]	L [mm]	D1 [mm]	D2 [mm]
01-3/8-011	8,0	22	13,3	19
01-3/8-012	10,0	22	15,8	19
01-3/8-013	11,0	22	17,0	19
01-3/8-014	12,0	22	18,3	19
01-3/8-015	13,0	22	19,5	22
01-3/8-016	14,0	22	20,8	22
01-3/8-017	15,0	25	21,9	22
01-3/8-018	16,0	25	23,3	22
01-3/8-019	17,0	25	24,5	22
01-3/8-020	18,0	25	25,8	22

Nasadki udarowe 6-kątne hexagon



Kod	A [mm]	L [mm]	D1 [mm]	D2 [mm]
01-3/8-073	7,0	30	12,5	19
01-3/8-074	8,0	30	14,0	19
01-3/8-075	9,0	30	15,0	19
01-3/8-076	10,0	30	16,0	19
01-3/8-077	11,0	30	17,5	19
01-3/8-078	12,0	30	19,0	19
01-3/8-079	13,0	30	20,0	22
01-3/8-080	14,0	30	21,0	22
01-3/8-081	15,0	30	22,0	22
01-3/8-082	16,0	30	24,0	22
01-3/8-083	17,0	30	25,0	22
01-3/8-084	18,0	30	26,0	22
01-3/8-085	19,0	30	27,5	22
01-3/8-086	5/16"	30	12,5	19
01-3/8-087	3/8"	30	14,5	19
01-3/8-088	1/2"	30	19,0	19

Nasadki udarowe 6-kątne hexagon z magnesem



Kod	A [mm]	L [mm]	D1 [mm]	D2 [mm]
01-3/8-041	8,0	30	14,0	19
01-3/8-042	9,0	30	15,0	19
01-3/8-043	10,0	30	16,0	19
01-3/8-044	11,0	30	17,5	19
01-3/8-045	12,0	30	19,0	19
01-3/8-046	13,0	30	20,0	22
01-3/8-047	14,0	30	21,0	22
01-3/8-048	15,0	30	22,0	22
01-3/8-049	16,0	30	24,0	22
01-3/8-050	17,0	30	25,0	22
01-3/8-051	18,0	30	26,0	22
01-3/8-052	19,0	30	27,5	22

Potrzebujesz inne długości takich nasadek?

Zrobimy je dla Ciebie na zamówienie w możliwym dla nas zakresie



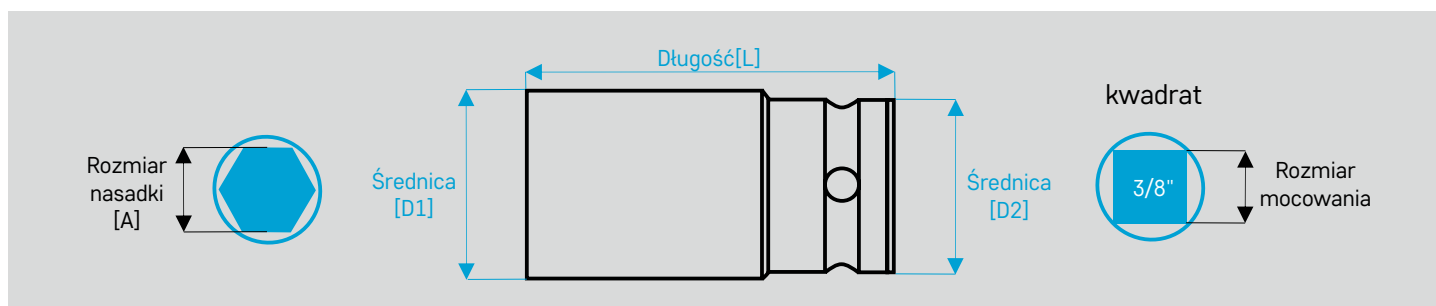

Nasadki udarowe 6-kątne hexagon - dłuższa wersja



Nasadki udarowe 6-kątne hexagon - dłuższa wersja z magnesem sprężynowym



Kod	A [mm]	L [mm]	D1 [mm]	D2 [mm]
01-3/8-109	8,0	50	13,3	19
01-3/8-110	9,0	50	14,5	19
01-3/8-111	10,0	50	15,8	19
01-3/8-112	11,0	50	17,0	19
01-3/8-113	12,0	50	18,3	19
01-3/8-114	13,0	50	19,5	22
01-3/8-115	14,0	50	20,8	22
01-3/8-116	15,0	50	21,9	22
01-3/8-117	16,0	50	23,2	22
01-3/8-118	17,0	50	24,4	22
01-3/8-119	18,0	50	25,7	22
01-3/8-120	19,0	50	26,9	22

Kod	A [mm]	L [mm]	D1 [mm]	D2 [mm]
01-3/8-143	8,0	55	13,3	19
01-3/8-144	10,0	55	15,8	19
01-3/8-145	13,0	55	19,5	22

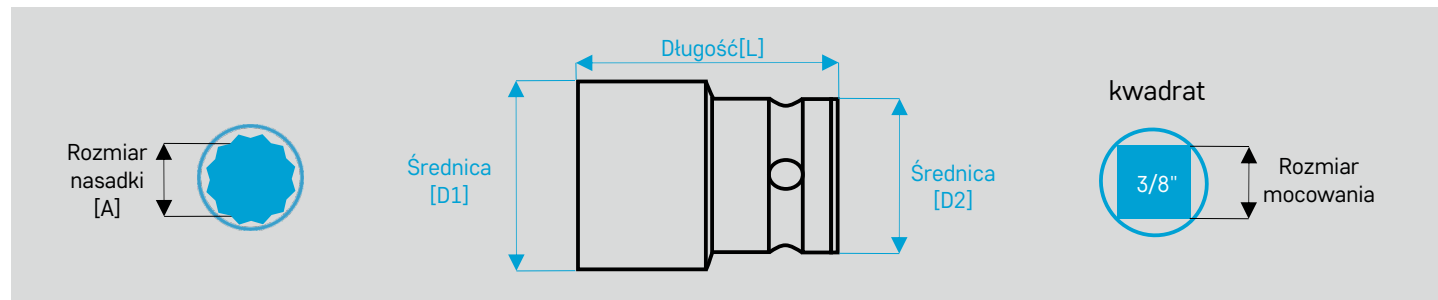

Nasadki udarowe 6-kątne hexagon - krótka wersja



Nasadki udarowe 6-kątne hexagon z magnesem



Kod	A [mm]	L [mm]	D1 [mm]	D2 [mm]
01-3/8-166	8,0	22	13,3	19
01-3/8-167	10,0	22	15,8	19
01-3/8-168	11,0	22	17,0	19
01-3/8-169	12,0	22	18,3	19
01-3/8-170	13,0	22	19,5	22
01-3/8-171	14,0	22	20,8	22
01-3/8-172	15,0	25	21,9	22
01-3/8-173	16,0	25	23,3	22
01-3/8-174	17,0	25	24,5	22
01-3/8-175	18,0	25	25,8	22

Kod	A [mm]	L [mm]	D1 [mm]	D2 [mm]
01-3/8-196	8,0	30	14,0	19
01-3/8-197	9,0	30	15,0	19
01-3/8-198	10,0	30	16,0	19
01-3/8-199	11,0	30	17,5	19
01-3/8-200	12,0	30	19,0	19
01-3/8-201	13,0	30	20,0	22
01-3/8-202	14,0	30	21,0	22
01-3/8-203	15,0	30	22,0	22
01-3/8-204	16,0	30	24,0	22
01-3/8-205	17,0	30	25,0	22
01-3/8-206	18,0	30	26,0	22
01-3/8-207	19,0	30	27,5	22

Potrzebujesz czegoś więcej? Dla nas to żaden problem!

10 Możemy wyprodukować narzędzia specjalne dostosowane do Twoich indywidualnych potrzeb.

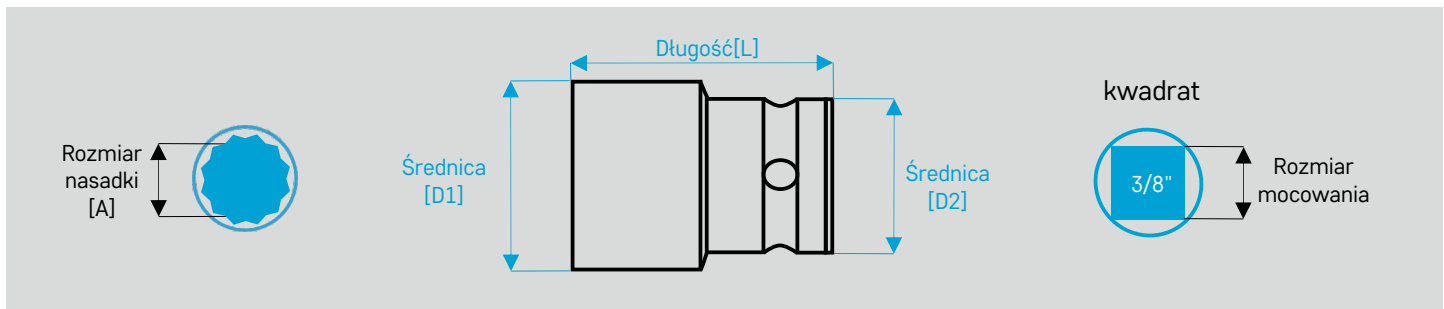

Nasadki udarowe 12-kątne double hexagon



Kod	A [mm]	L [mm]	D1 [mm]	D2 [mm]
01-3/8-228	7,0	30	12,5	19
01-3/8-229	8,0	30	14,0	19
01-3/8-230	9,0	30	15,0	19
01-3/8-231	10,0	30	16,0	19
01-3/8-232	11,0	30	17,5	19
01-3/8-233	12,0	30	19,0	19
01-3/8-234	13,0	30	20,0	22
01-3/8-235	14,0	30	21,0	22
01-3/8-236	15,0	30	22,0	22
01-3/8-237	16,0	30	24,0	22
01-3/8-238	17,0	30	25,0	22
01-3/8-239	18,0	30	26,0	22
01-3/8-240	19,0	30	27,5	22
01-3/8-241	5/16"	30	12,5	19
01-3/8-242	3/8"	30	14,5	19
01-3/8-243	1/2"	30	19,0	19

Nasadki udarowe 12-kątne double hexagon



Kod	A [mm]	L [mm]	D1 [mm]	D2 [mm]
01-3/8-371	9,0	32	14,5	19
01-3/8-372	10,0	32	15,8	19
01-3/8-373	11,0	32	17,0	19
01-3/8-374	13,0	32	19,5	22
01-3/8-375	15,0	32	21,9	22
01-3/8-376	17,0	32	24,5	22
01-3/8-377	19,0	32	27,0	22

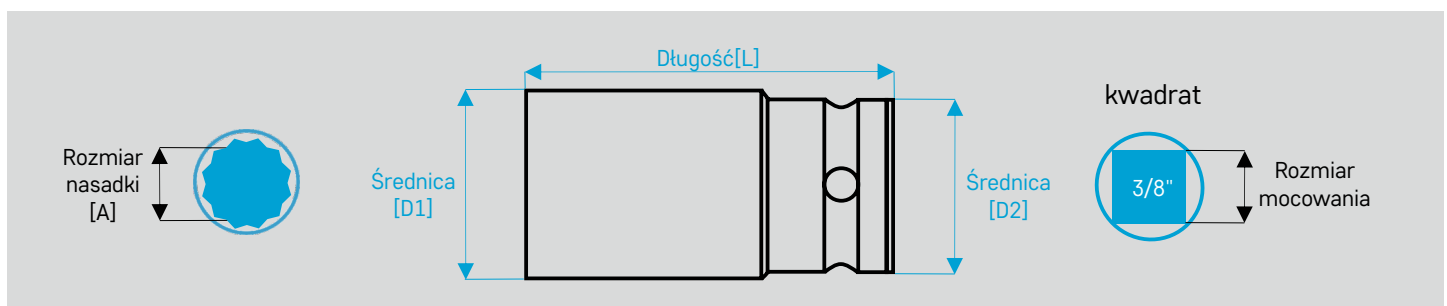

Nasadki udarowe 12-kątne double hexagon - dłuższa wersja



Kod	A [mm]	L [mm]	D1 [mm]	D2 [mm]
01-3/8-264	8,0	50	13,3	19
01-3/8-265	9,0	50	14,5	19
01-3/8-266	10,0	50	15,8	19
01-3/8-267	11,0	50	17,0	19
01-3/8-268	12,0	50	18,3	19
01-3/8-269	13,0	50	19,5	22
01-3/8-270	14,0	50	20,8	22
01-3/8-271	15,0	50	21,9	22
01-3/8-272	16,0	50	23,2	22
01-3/8-273	17,0	50	24,4	22
01-3/8-274	18,0	50	25,7	22
01-3/8-275	19,0	50	26,9	22

Nasadki udarowe 12-kątne double hexagon - dłuższa wersja z magnesem sprężynowym



Kod	A [mm]	L [mm]	D1 [mm]	D2 [mm]
01-3/8-296	8,0	55	13,3	19
01-3/8-297	10,0	55	15,8	19
01-3/8-298	13,0	55	19,5	22

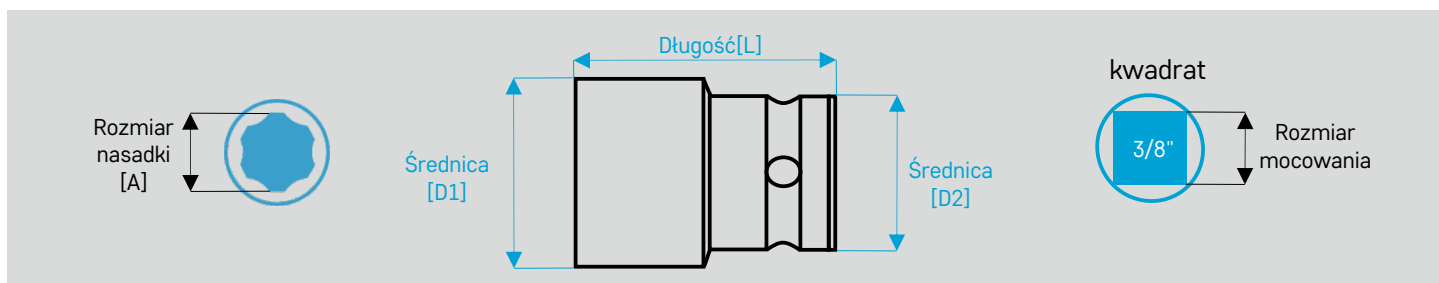

Nasadki udarowe 6-kątne hexagon Surface Drive TORX® PLUS



Kod	A [mm]	L [mm]	D1 [mm]	D2 [mm]
01-3/8-319	10,0	32	16,0	19
01-3/8-320	11,0	32	17,5	19
01-3/8-321	13,0	32	20,0	22
01-3/8-322	15,0	32	22,0	22
01-3/8-323	16,0	32	24,0	22
01-3/8-324	17,0	32	25,0	22
01-3/8-325	18,0	32	26,0	22
01-3/8-326	19,0	32	28,0	22

Nasadki udarowe 6-kątne hexagon Surface Drive TORX® PLUS z magnesem



Kod	A [mm]	L [mm]	D1 [mm]	D2 [mm]
01-3/8-347	10,0	32	16,0	19
01-3/8-348	13,0	32	20,0	22
01-3/8-349	16,0	32	24,0	22
01-3/8-350	17,0	32	25,0	22

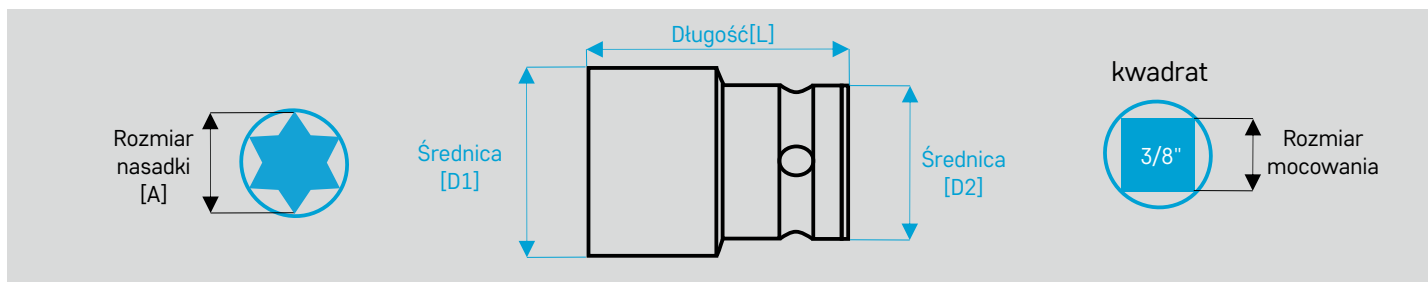

Nasadki udarowe TORX® socket screws



Kod	A [mm]	L [mm]	D1 [mm]	D2 [mm]
01-3/8-398	E5	32	9,0	19
01-3/8-399	E6	32	10,2	19
01-3/8-400	E7	32	10,2	19
01-3/8-401	E8	32	10,5	19
01-3/8-402	E10	32	12,5	19
01-3/8-403	E12	32	14,9	19
01-3/8-404	E14	32	17,2	19

Nasadki udarowe TORX® socket screws z magnesem



Kod	A [mm]	L [mm]	D1 [mm]	D2 [mm]
01-3/8-425	E8	32	10,5	19
01-3/8-426	E10	32	12,5	19
01-3/8-427	E12	32	14,9	19
01-3/8-428	E14	32	17,2	19

Potrzebujesz czegoś więcej? Dla nas to żaden problem!

12 Możemy wyprodukować narzędzia specjalne dostosowane do Twoich indywidualnych potrzeb.

01 Nasadki udarowe 3/8"

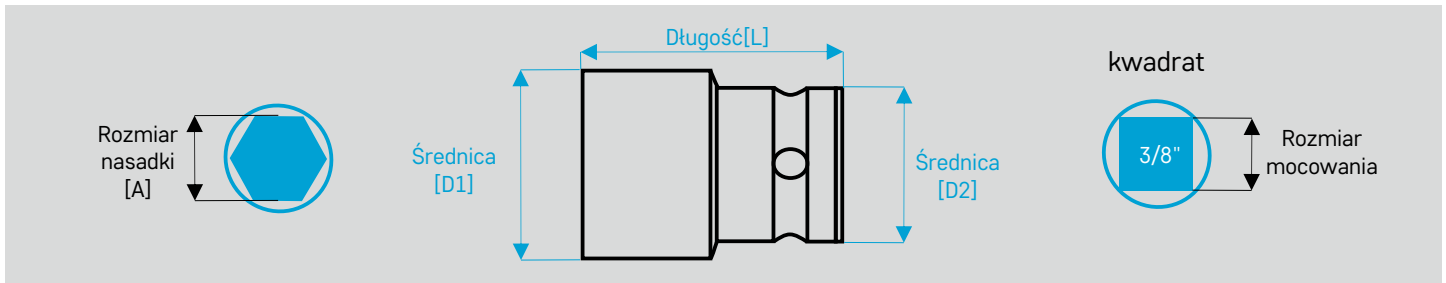

Nasadki udarowe 6-kątne hexagon
- krótka wersja cienkościenne



Kod	A [mm]	L [mm]	D1 [mm]	D2 [mm]
01-3/8-449	8,0	32	12,3	18,5
01-3/8-450	9,0	32	13,5	18,5
01-3/8-451	10,0	32	14,8	18,5
01-3/8-452	11,0	32	16,0	18,5
01-3/8-453	12,0	32	17,3	18,5
01-3/8-454	13,0	32	18,5	21,5
01-3/8-455	14,0	32	19,8	21,5
01-3/8-456	15,0	32	21,0	21,5
01-3/8-457	16,0	32	22,3	21,5
01-3/8-458	17,0	32	23,5	21,5
01-3/8-459	18,0	32	24,8	21,5
01-3/8-460	19,0	32	26,0	21,5

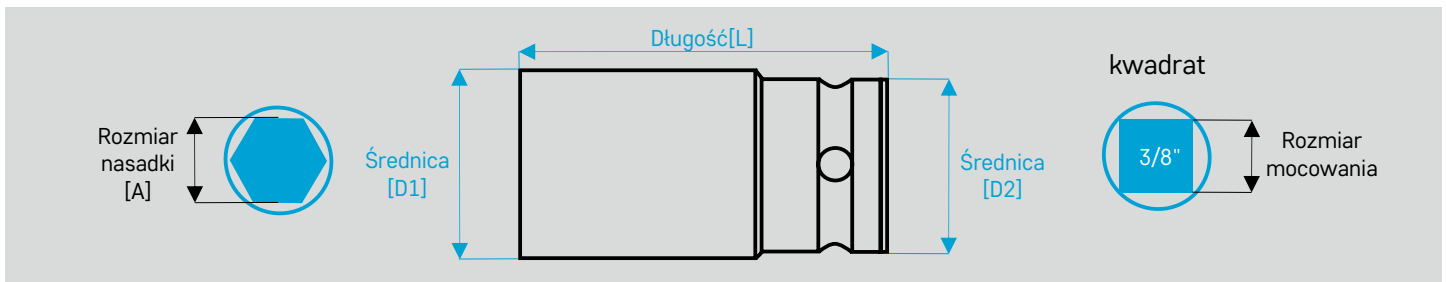

Nasadki udarowe 6-kątne hexagon
- dłuższa wersja cienkościenne



Kod	A [mm]	L [mm]	D1 [mm]	D2 [mm]
01-3/8-481	8,0	50	12,3	18,5
01-3/8-482	10,0	50	14,8	18,5
01-3/8-483	11,0	50	16,0	18,5
01-3/8-484	12,0	50	17,3	18,5
01-3/8-485	13,0	50	18,5	21,5
01-3/8-486	14,0	50	19,8	21,5
01-3/8-487	15,0	50	21,0	21,5
01-3/8-488	16,0	50	22,3	21,5
01-3/8-489	17,0	50	23,5	21,5
01-3/8-490	18,0	50	24,8	21,5
01-3/8-491	19,0	50	26,0	21,5

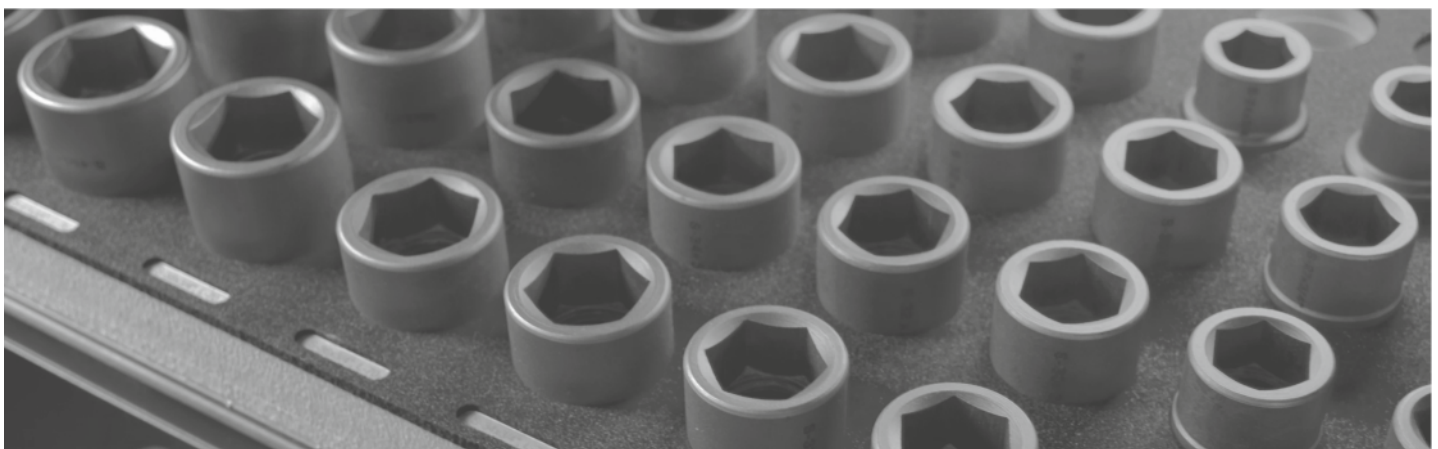

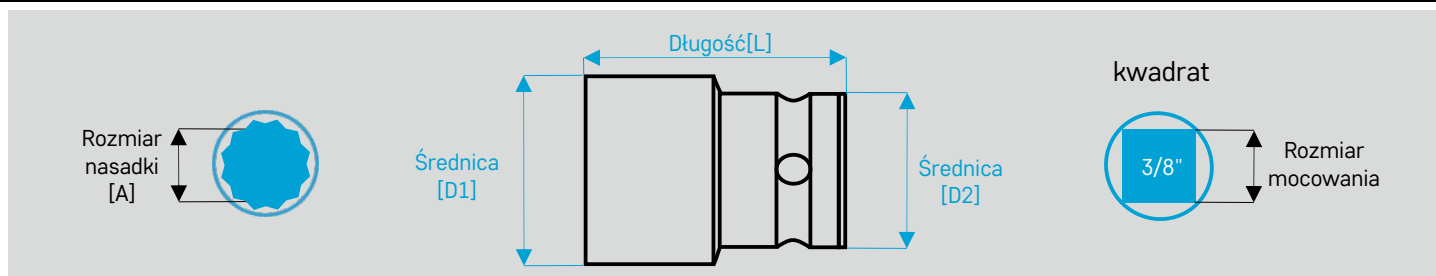

Nasadki udarowe 12-kątne double hexagon - krótka wersja cienkościenne



Kod	A [mm]	L [mm]	D1 [mm]	D2 [mm]
01-3/8-512	8,0	32	12,3	18,5
01-3/8-513	9,0	32	13,5	18,5
01-3/8-514	10,0	32	14,8	18,5
01-3/8-515	11,0	32	16,0	18,5
01-3/8-516	12,0	32	17,3	18,5
01-3/8-517	13,0	32	18,5	21,5
01-3/8-518	14,0	32	19,8	21,5
01-3/8-519	15,0	32	21,0	21,5
01-3/8-520	16,0	32	22,3	21,5
01-3/8-521	17,0	32	23,5	21,5
01-3/8-522	18,0	32	24,8	21,5
01-3/8-523	19,0	32	26,0	21,5

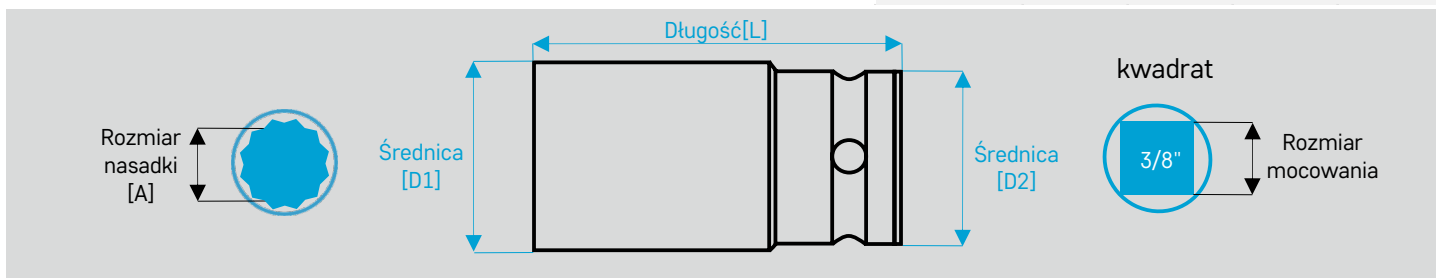

Nasadki udarowe 12-kątne double hexagon - dłuższa wersja cienkościenne



Kod	A [mm]	L [mm]	D1 [mm]	D2 [mm]
01-3/8-544	8,0	50	12,3	18,5
01-3/8-545	10,0	50	14,8	18,5
01-3/8-546	11,0	50	16,0	18,5
01-3/8-547	12,0	50	17,3	18,5
01-3/8-548	13,0	50	18,5	21,5
01-3/8-549	14,0	50	19,8	21,5
01-3/8-550	15,0	50	21,0	21,5
01-3/8-551	16,0	50	22,3	21,5
01-3/8-552	17,0	50	23,5	21,5
01-3/8-553	18,0	50	24,8	21,5
01-3/8-554	19,0	50	26,0	21,5

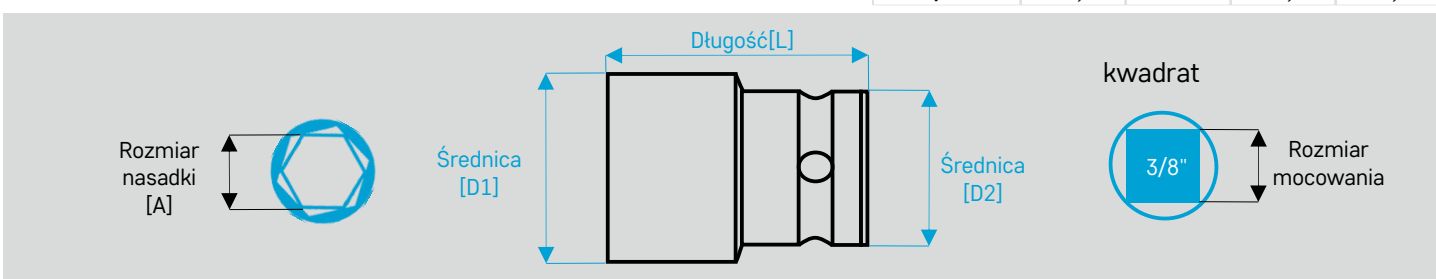

Nasadki udarowe 6-kątne hexagon fast lead



Kod	A [mm]	L [mm]	D1 [mm]	D2 [mm]
01-3/8-575	10,0	32	15,8	19,0
01-3/8-576	11,0	32	17,0	19,0
01-3/8-577	12,0	32	18,3	19,0
01-3/8-578	13,0	32	19,5	22,0
01-3/8-579	14,0	32	20,8	22,0
01-3/8-580	15,0	32	22,0	22,0
01-3/8-581	16,0	32	23,3	22,0
01-3/8-582	17,0	32	24,5	22,0
01-3/8-583	18,0	32	25,8	22,0
01-3/8-584	19,0	32	27,0	22,0

Potrzebujesz inne długości?

Zrobimy je dla Ciebie
na zamówienie
w możliwym dla nas zakresie

L [mm]
← 25 min → 140 max →

Potrzebujesz czegoś więcej? Dla nas to żaden problem!

14 Możemy wyprodukować narzędzia specjalne dostosowane do Twoich indywidualnych potrzeb.

01 Nasadki udarowe 3/8"

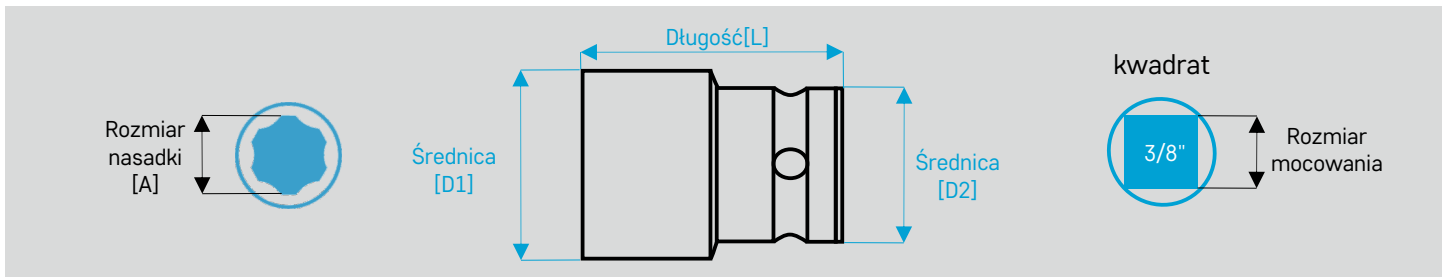

Nasadki udarowe 6-kątne hexagon Surface Drive TORX® PLUS cienkościenne



Kod	A [mm]	L [mm]	D1 [mm]	D2 [mm]
01-3/8-505	8,0	32	12,3	18,5
01-3/8-506	10,0	32	14,8	18,5
01-3/8-507	12,0	32	17,3	18,5
01-3/8-508	13,0	32	18,5	21,5
01-3/8-509	16,0	32	22,3	21,5

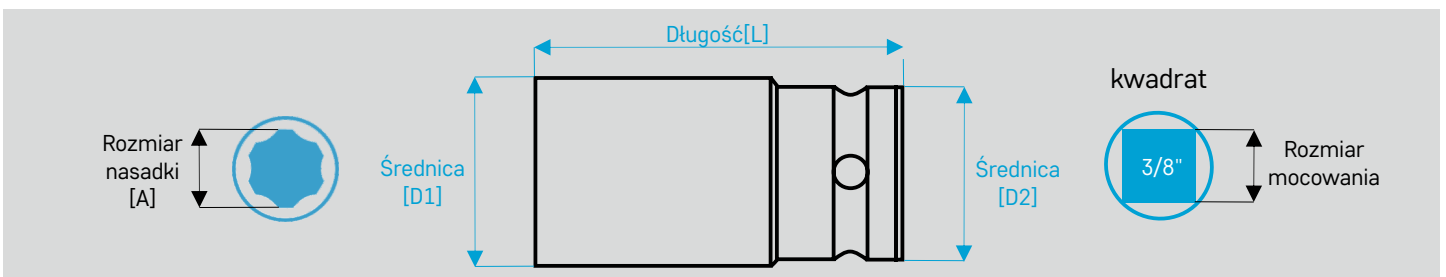

Nasadki udarowe 6-kątne hex. Surface Drive TORX® PLUS cienkościenne - wersja dłuższa



Kod	A [mm]	L [mm]	D1 [mm]	D2 [mm]
01-3/8-530	8,0	32	12,3	18,5
01-3/8-531	8,0	50	12,3	18,5
01-3/8-532	9,0	50	13,5	18,5
01-3/8-533	10,0	50	14,8	18,5
01-3/8-534	11,0	50	16,0	18,5
01-3/8-535	12,0	50	17,3	18,5
01-3/8-536	13,0	50	18,5	21,5
01-3/8-537	15,0	50	21,0	21,5
01-3/8-538	16,0	50	22,3	21,5
01-3/8-539	17,0	50	23,5	21,5
01-3/8-540	18,0	50	24,8	21,5
01-3/8-541	19,0	50	26,0	21,5

Potrzebujesz inne długości?

Zrobimy je dla Ciebie na zamówienie w możliwym dla nas zakresie

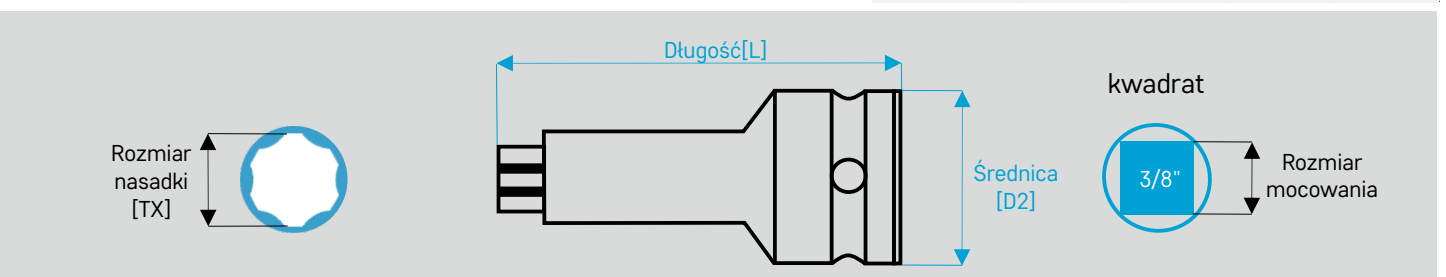

Nasadki wkrętakowe TORX® PLUS socket screws



Kod	TX [mm]	L [mm]	D2 [mm]
01-3/8-562	30,0	50	19,0
01-3/8-563	40,0	50	19,0
01-3/8-564	45,0	50	19,0
01-3/8-565	50,0	50	19,0

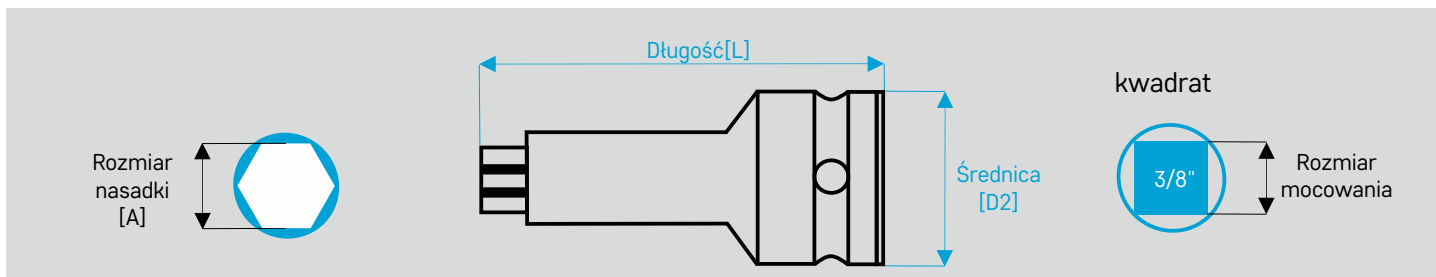

Nasadki wkrętakowe 6-kątne hexagon



Potrzebujesz inne długości?

Zrobimy je dla Ciebie
na zamówienie
w możliwym dla nas zakresie



Kod	A [mm]	L [mm]	D2 [mm]
01-3/8-586	3,0	50	16,0
01-3/8-587	4,0	50	16,0
01-3/8-588	5,0	50	16,0
01-3/8-589	6,0	50	16,0
01-3/8-590	8,0	50	16,0
01-3/8-591	10,0	50	16,0
01-3/8-592	12,0	50	16,0
01-3/8-593	14,0	50	16,0
01-3/8-594	15,0	50	5,5
01-3/8-595	16,0	50	21,5
01-3/8-596	17,0	50	21,5
01-3/8-597	18,0	50	21,5
01-3/8-598	19,0	50	21,5

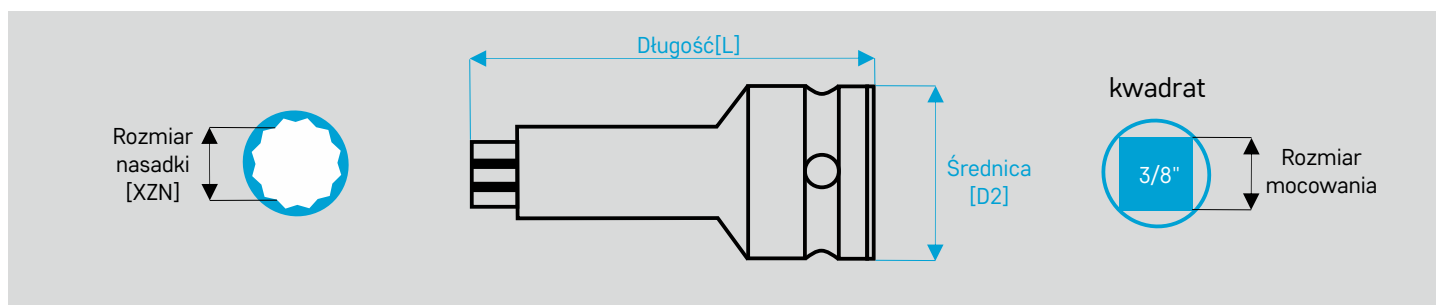

Nasadki wkrętakowe XZN

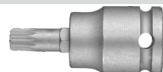

Kod	XZN [mm]	L [mm]	D2 [mm]
01-3/8-629	M6	50	19,0
01-3/8-630	M8	50	19,0
01-3/8-631	M10	50	19,0
01-3/8-632	M12	50	19,0
01-3/8-633	M14	50	19,0
01-3/8-634	M16	50	19,0
01-3/8-635	M18	50	19,0

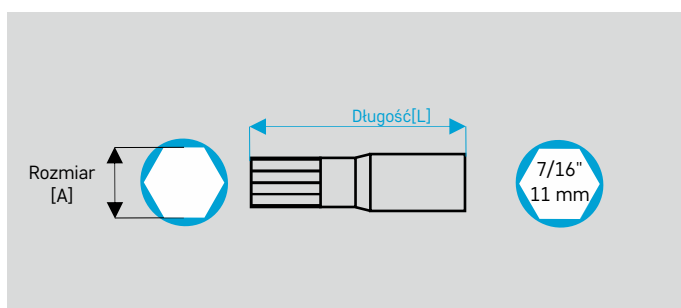

Końcówki imbusowe 7/16" - 11 mm

Kod	A [mm]	L [mm]
01-7/16-011	5,0	35,0
01-7/16-012	6,0	35,0
01-7/16-013	8,0	35,0
01-7/16-014	10,0	35,0
01-7/16-015	12,0	35,0
01-7/16-016	14,0	35,0
01-7/16-017	17,0	35,0

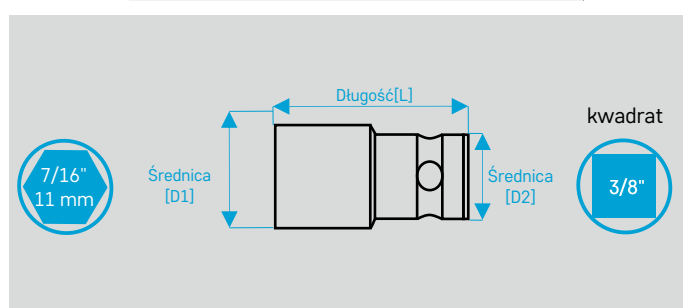

Adaptory 6-kątne hexagon 7/16" - 11 mm

Kod	L [mm]	D1 [mm]	D2 [mm]
01-3/8-657	2	22,0	22,0



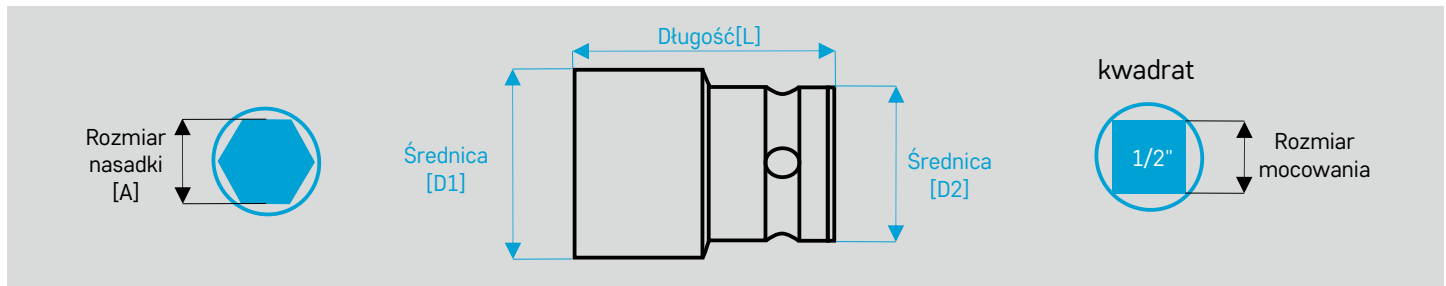

Nasadki udarowe 6-kątne hexagon



Kod	A [mm]	L [mm]	D1 [mm]	D2 [mm]
01-1/2-011	8,0	38	14,5	25
01-1/2-012	9,0	38	16	25
01-1/2-013	10,0	38	17	25
01-1/2-014	11,0	38	18,5	25
01-1/2-015	12,0	38	19,5	25
01-1/2-016	13,0	38	21	25
01-1/2-017	14,0	38	22	25
01-1/2-018	15,0	38	23,5	30
01-1/2-019	16,0	38	25	30
01-1/2-020	17,0	38	26	30
01-1/2-021	17,0 R	38	38	33
01-1/2-022	18,0	38	27	30
01-1/2-023	19,0	38	28	30
01-1/2-024	19,0 R	38	38	33
01-1/2-025	20,0	38	30	30
01-1/2-026	21,0	38	31	30
01-1/2-027	22,0	38	32,5	30
01-1/2-028	24,0	45	35	30
01-1/2-029	27,0	50	39	30
01-1/2-030	30,0	50	42	30
01-1/2-031	32,0	50	44	30
01-1/2-032	36,0	50	48	30
01-1/2-033	3/8"	38	16	25

Nasadki udarowe 6-kątne hexagon z magnesem



Kod	A [mm]	L [mm]	D1 [mm]	D2 [mm]
01-1/2-054	10,0	38	17,5	25
01-1/2-055	11,0	38	18,7	25
01-1/2-056	12,0	38	20	25
01-1/2-057	13,0	38	21	25
01-1/2-058	14,0	38	22,5	25
01-1/2-059	15,0	38	23,7	30
01-1/2-060	16,0	38	25	30
01-1/2-061	17,0	38	26,5	30
01-1/2-062	18,0	38	27,5	30
01-1/2-063	19,0	38	29	30
01-1/2-064	3/8"	38	17,4	25
01-1/2-065	1/2"	38	21	25

Potrzebujesz inne długości?

Zrobimy je dla Ciebie
na zamówienie
w możliwym dla nas zakresie

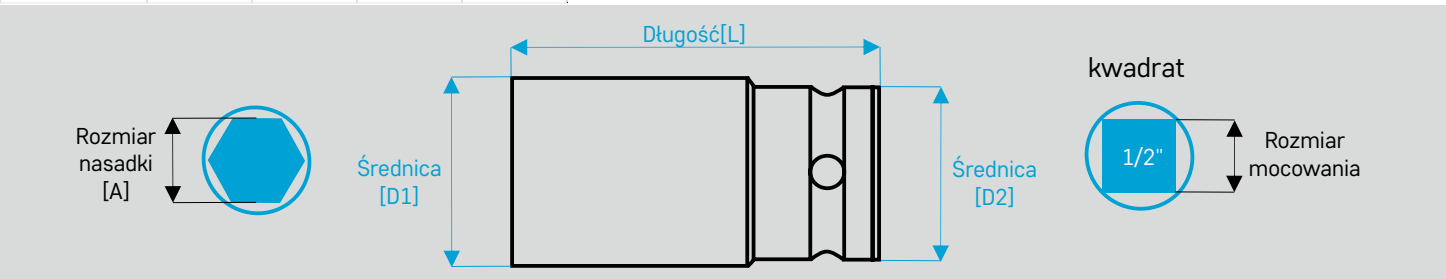

Nasadki udarowe 6-kątne hexagon - półdługa wersja



Kod	A [mm]	L [mm]	D1 [mm]	D2 [mm]
01-1/2-086	10,0	57	17	25
01-1/2-087	11,0	57	18,2	25
01-1/2-088	12,0	57	19,5	25
01-1/2-089	13,0	57	20,7	25
01-1/2-090	14,0	57	22	25
01-1/2-091	15,0	57	23,2	30
01-1/2-092	16,0	57	24,5	30
01-1/2-093	17,0	57	25,7	30
01-1/2-094	18,0	57	27	30
01-1/2-095	19,0	57	28,2	30

Nasadki udarowe 6-kątne hexagon - dłuższa wersja



Kod	A [mm]	L [mm]	D1 [mm]	D2 [mm]
01-1/2-126	8,0	78	15	25
01-1/2-127	10,0	78	17,5	25
01-1/2-128	13,0	78	21	25
01-1/2-129	14,0	78	22,5	25
01-1/2-130	15,0	75	23,5	30
01-1/2-131	16,0	78	25	30
01-1/2-132	17,0	78	26	30
01-1/2-133	18,0	78	27,5	30
01-1/2-134	19,0	78	28,7	30
01-1/2-135	21,0	78	31	30
01-1/2-136	22,0	78	32	30
01-1/2-137	24,0	78	35	30
01-1/2-138	27,0	78	38,5	30
01-1/2-139	30,0	78	42,5	30
01-1/2-140	32,0	78	44	30
01-1/2-141	36,0	78	48	30

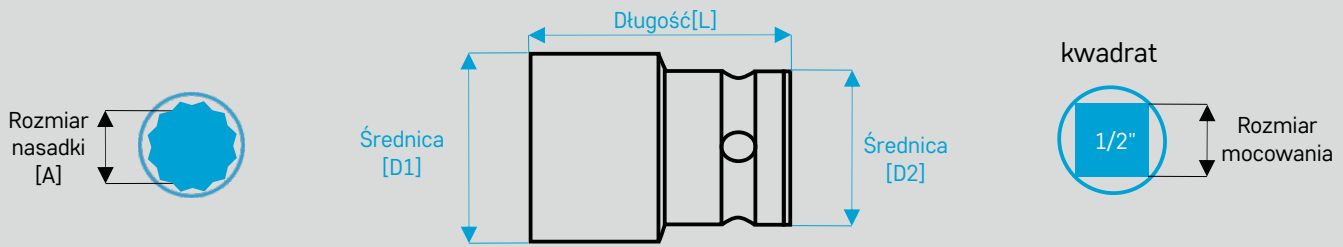

Nasadki udarowe 12-kątne
double hexagon



Kod	A [mm]	L [mm]	D1 [mm]	D2 [mm]
01-1/2-162	8,0	38	14,5	25
01-1/2-163	9,0	38	16	25
01-1/2-164	10,0	38	17	25
01-1/2-165	11,0	38	18,5	25
01-1/2-166	12,0	38	19,5	25
01-1/2-167	13,0	38	21	25
01-1/2-168	14,0	38	22	25
01-1/2-169	15,0	38	23,5	30
01-1/2-170	16,0	38	25	30
01-1/2-171	17,0	38	26	30
01-1/2-172	17,0 R	38	38	33
01-1/2-173	18,0	38	27	30
01-1/2-174	19,0	38	28	30
01-1/2-175	19,0 R	38	38	33
01-1/2-176	20,0	38	30	30
01-1/2-177	21,0	38	31	30
01-1/2-178	22,0	38	32,5	30
01-1/2-179	24,0	45	35	30
01-1/2-180	27,0	50	39	30
01-1/2-181	30,0	50	42	30
01-1/2-182	32,0	50	44	30
01-1/2-183	36,0	50	48	30
01-1/2-184	3/8"	38	16	25

Nasadki udarowe 12-kątne
double hexagon z magnesem



Kod	A [mm]	L [mm]	D1 [mm]	D2 [mm]
01-1/2-205	10,0	38	17,5	25
01-1/2-206	11,0	38	18,7	25
01-1/2-207	12,0	38	20	25
01-1/2-208	13,0	38	21	25
01-1/2-209	14,0	38	22,5	25
01-1/2-210	15,0	38	23,7	30
01-1/2-211	16,0	38	25	30
01-1/2-212	17,0	38	26,5	30
01-1/2-213	18,0	38	27,5	30
01-1/2-214	19,0	38	29	30
01-1/2-215	3/8"	38	17,4	25
01-1/2-216	1/2"	38	21	25

Nasadki udarowe 12-kątne
double hexagon



Kod	A [mm]	L [mm]	D1 [mm]	D2 [mm]
01-1/2-490	9,0	38	15,0	24
01-1/2-491	10,0	38	17,0	24
01-1/2-492	11,0	38	18,0	24
01-1/2-493	13,0	38	20,0	24
01-1/2-494	15,0	38	24,0	30
01-1/2-495	16,0	38	24,0	30
01-1/2-496	17,0	38	26,0	30
01-1/2-497	18	38	26	30
01-1/2-498	19	38	28	30
01-1/2-499	21	38	30	30
01-1/2-500	22	38	32	30

Potrzebujesz inne długości?

Zrobimy je dla Ciebie
w możliwym dla nas zakresie



Potrzebujesz czegoś więcej? Dla nas to żaden problem!

18 Możemy wyprodukować narzędzia specjalne dostosowane do Twoich indywidualnych potrzeb.

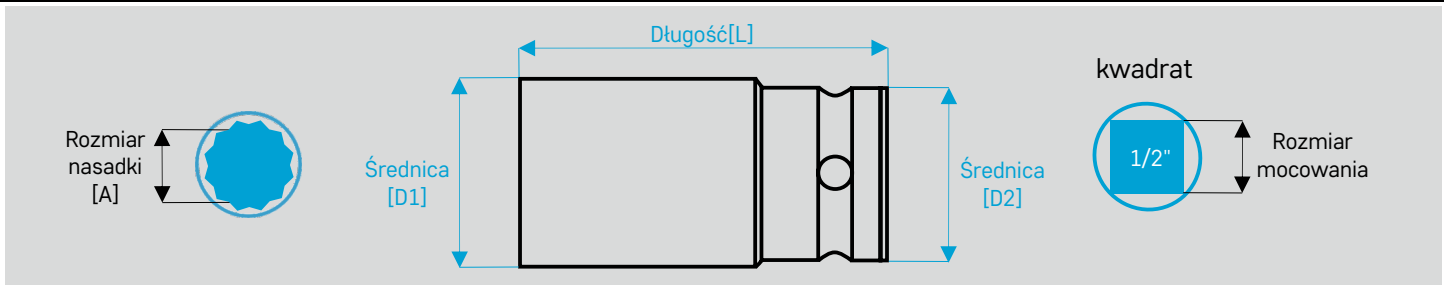

Nasadki udarowe 12-kątne double hexagon - półdługa wersja



Kod	A [mm]	L [mm]	D1 [mm]	D2 [mm]
01-1/2-237	10,0	57	17	25
01-1/2-238	11,0	57	18,2	25
01-1/2-239	12,0	57	19,5	25
01-1/2-240	13,0	57	20,7	25
01-1/2-241	14,0	57	22	25
01-1/2-242	15,0	57	23,2	30
01-1/2-243	16,0	57	24,5	30
01-1/2-244	17,0	57	25,7	30
01-1/2-245	18,0	57	27	30
01-1/2-246	19,0	57	28,2	30

Nasadki udarowe 12-kątne double hexagon - dłuższa wersja



Kod	A [mm]	L [mm]	D1 [mm]	D2 [mm]
01-1/2-267	8,0	78	15	25
01-1/2-268	10,0	78	17,5	25
01-1/2-269	13,0	78	21	25
01-1/2-270	14,0	78	22,5	25
01-1/2-271	15,0	75	23,5	30
01-1/2-272	16,0	78	25	30
01-1/2-273	17,0	78	26	30
01-1/2-274	18,0	78	27,5	30
01-1/2-275	19,0	78	28,7	30
01-1/2-276	21,0	78	31	30
01-1/2-277	22,0	78	32	30
01-1/2-278	24,0	78	35	30
01-1/2-279	27,0	78	38,5	30
01-1/2-280	30,0	78	42,5	30
01-1/2-281	32,0	78	44	30
01-1/2-282	36,0	78	48	30

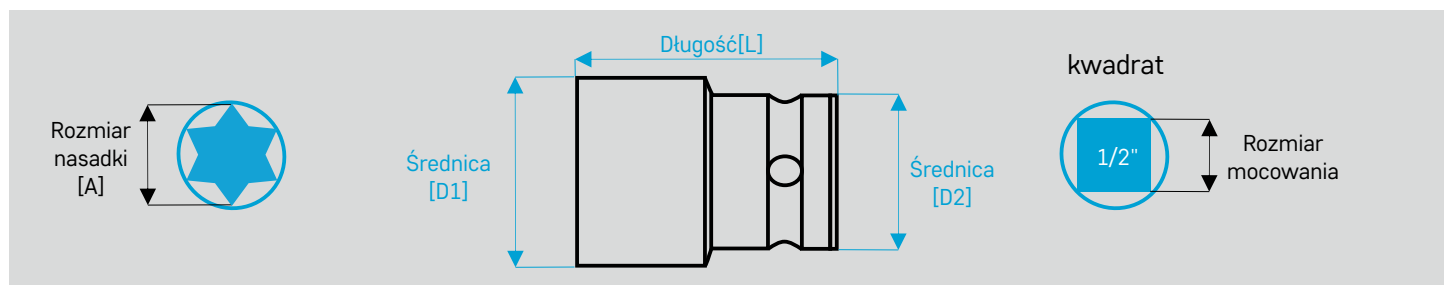

Nasadki udarowe TORX® socket screws



Kod	A [mm]	L [mm]	D1 [mm]	D2 [mm]
01-1/2-303	E 10	38	15,0	25
01-1/2-304	E 12	38	16,0	25
01-1/2-305	E 14	38	18,5	25
01-1/2-306	E 16	38	20,0	25
01-1/2-307	E 18	38	22,0	25
01-1/2-308	E 20	38	25,0	30
01-1/2-309	E 24	45	30,0	30

Nasadki udarowe TORX® socket screws z magnesem



Kod	A [mm]	L [mm]	D1 [mm]	D2 [mm]
01-1/2-330	E10	38	15,0	25
01-1/2-331	E12	38	16,0	25
01-1/2-332	E14	38	18,5	25
01-1/2-333	E16	38	20,0	25
01-1/2-334	E18	38	22,0	25

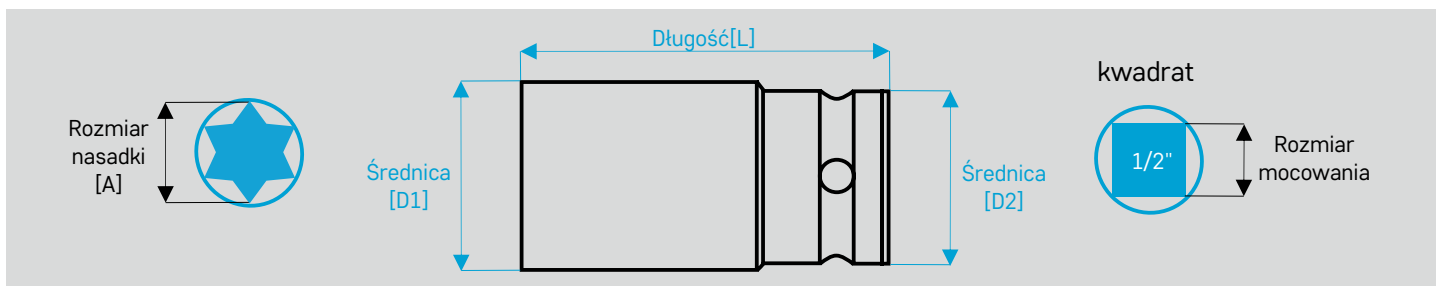

Nasadki udarowe TORX®
socket screws - dłuższa wersja



Kod	A [mm]	L [mm]	D1 [mm]	D2 [mm]
01-1/2-355	E10	80	14,0	25
01-1/2-356	E12	80	15,0	25
01-1/2-357	E14	80	18,0	25
01-1/2-358	E16	80	19,0	25
01-1/2-359	E18	80	22,0	30
01-1/2-360	E20	80	24,0	30

Potrzebujesz inne długości?

Zrobimy je dla Ciebie
w możliwym dla nas zakresie

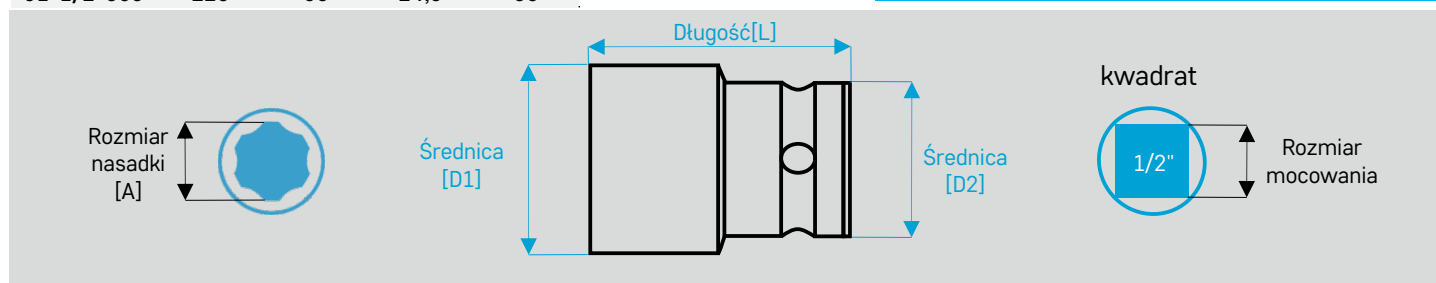
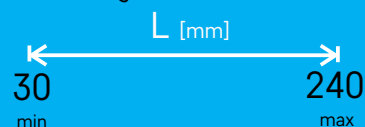

Nasadki udarowe 6-kątne hexagon Surface Drive
TORX® PLUS



Kod	A [mm]	L [mm]	D1 [mm]	D2 [mm]
01-1/2-381	10,0	38,0	17,5	25,0
01-1/2-382	13,0	38,0	21,0	25,0
01-1/2-383	15,0	38,0	23,7	30,0
01-1/2-384	16,0	38,0	25,0	30,0
01-1/2-385	17,0	38,0	26,0	30,0
01-1/2-386	18,0	38,0	27,5	30,0
01-1/2-387	19,0	38,0	28,7	30,0
01-1/2-388	21,0	38,0	30,0	30,0
01-1/2-389	22,0	38,0	32,0	30,0

Potrzebujesz inne długości?

Zrobimy je dla Ciebie
w możliwym dla nas zakresie

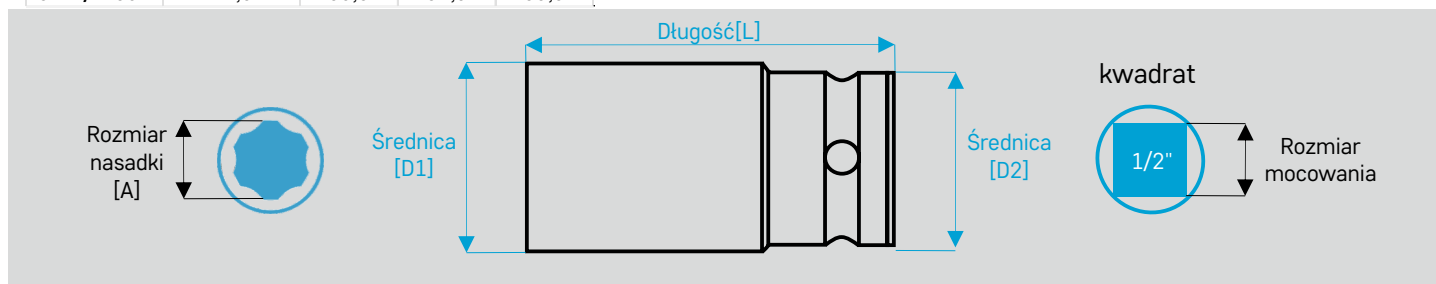
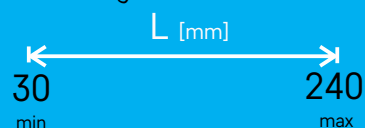

Nasadki udarowe 6-kątne hexagon Surface Drive
TORX® PLUS - dłuższa wersja



Kod	A [mm]	L [mm]	D1 [mm]	D2 [mm]
01-1/2-430	10,0	83,0	17,5	25,0
01-1/2-431	12,0	83,0	20,0	25,0
01-1/2-432	13,0	83,0	21,0	25,0
01-1/2-433	14,0	83,0	22,3	25,0
01-1/2-434	15,0	83,0	23,6	30,0
01-1/2-435	16,0	83,0	25,0	30,0
01-1/2-436	17,0	83,0	26,0	30,0
01-1/2-437	18,0	83,0	27,5	30,0
01-1/2-438	19,0	83,0	28,7	30,0

Potrzebujesz inne długości?

Zrobimy je dla Ciebie
w możliwym dla nas zakresie

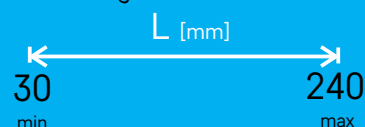

Potrzebujesz czegoś więcej? Dla nas to żaden problem!

20 Możemy wyprodukować narzędzia specjalne dostosowane do Twoich indywidualnych potrzeb.

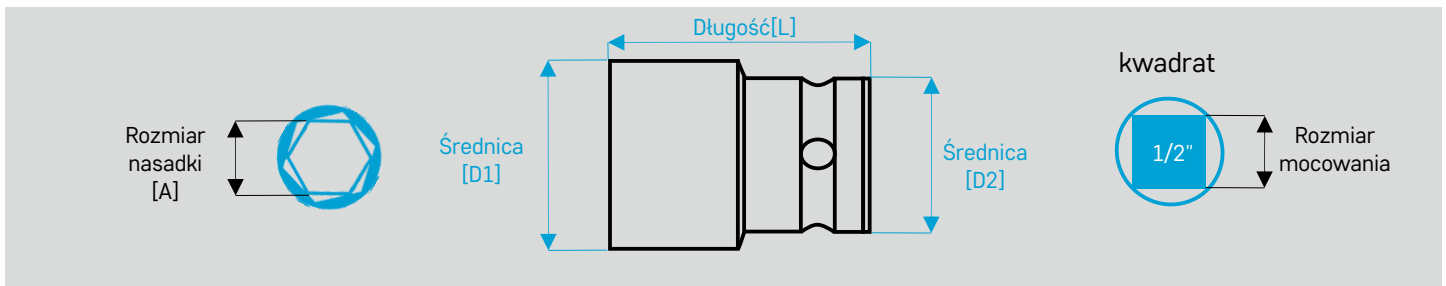

Nasadki udarowe 6-kątne hexagon fast lead



Kod	A [mm]	L [mm]	D1 [mm]	D2 [mm]
01-1/2-459	10,0	38,0	17,0	25,0
01-1/2-460	13,0	38,0	20,8	25,0
01-1/2-461	15,0	38,0	23,5	30,0
01-1/2-462	16,0	38,0	24,5	30,0
01-1/2-463	17,0	38,0	25,7	30,0
01-1/2-464	18,0	38,0	27,0	30,0
01-1/2-465	19,0	38,0	28,2	30,0
01-1/2-466	21,0	38,0	30,7	30,0
01-1/2-467	22,0	38,0	32,0	30,0
01-1/2-468	24,0	38,0	34,5	30,0
01-1/2-469	27,0	38,0	38,2	30,0

Potrzebujesz inne długości?

Zrobimy je dla Ciebie w możliwym dla nas zakresie

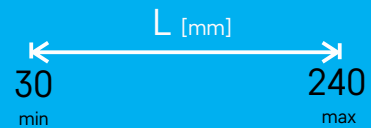

NASADKI FAST LEAD

Dzięki zastosowaniu odpowiedniego kąta na sześciokątnych powierzchniach, pełne mocowanie uzyskuje się niemal natychmiast.

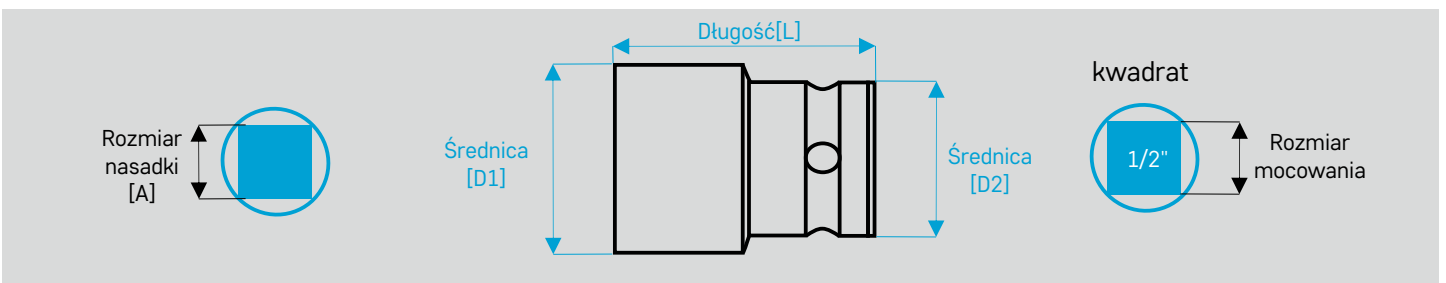

Nasadki udarowe kwadrat



Kod	A [mm]	L [mm]	D1 [mm]	D2 [mm]
01-1/2-521	10,0	40	21,5	25
01-1/2-522	12,0	40	24,0	25
01-1/2-523	13,0	40	26,0	30
01-1/2-524	14,0	40	27,5	30
01-1/2-525	17,0	40	32,0	30
01-1/2-526	19,0	45	36,0	30
01-1/2-527	22,0	45	42,0	30
01-1/2-528	24,0	50	44,0	30

Potrzebujesz inne długości?

Zrobimy je dla Ciebie w możliwym dla nas zakresie



Potrzebujesz inny rozmiar nasadki?

Zrobimy je dla Ciebie w możliwym dla nas zakresie



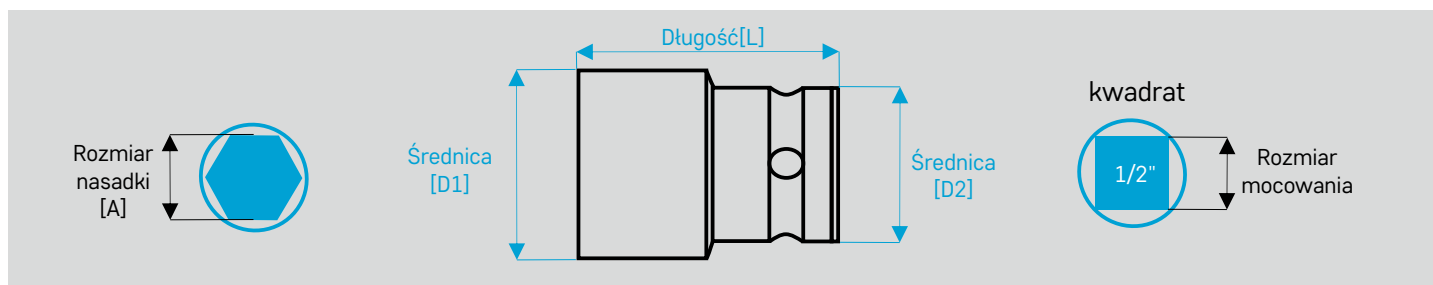

Nasadki udarowe 6-kątne hexagon
- krótka wersja cienkościenne



Kod	A [mm]	L [mm]	D1 [mm]	D2 [mm]
01-1/2-557	10,0	38	15,5	22,0
01-1/2-558	11,0	38	16,7	22,0
01-1/2-559	12,0	38	18,0	22,0
01-1/2-560	13,0	38	19,2	22,0
01-1/2-561	14,0	38	21,0	24,0
01-1/2-562	15,0	38	21,7	24,0
01-1/2-563	16,0	38	23,0	24,0
01-1/2-564	17,0	38	24,0	24,0
01-1/2-565	18,0	38	25,0	25,0
01-1/2-566	19,0	38	26,0	26,0
01-1/2-567	21,0	38	29,5	28,0
01-1/2-568	22,0	38	30,9	29,5

Potrzebujesz inne długości?

Zrobimy je dla Ciebie
w możliwym dla nas zakresie

L [mm]

50 min 240 max

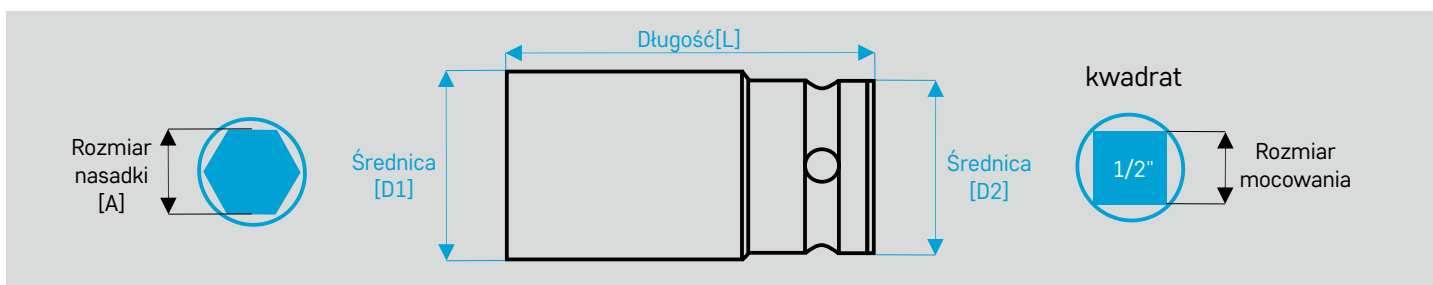

Nasadki udarowe 6-kątne hexagon
- dłuższa wersja cienkościenne



Kod	A [mm]	L [mm]	D1 [mm]	D2 [mm]
01-1/2-589	10,0	78	15,5	22,0
01-1/2-590	13,0	78	19,2	24,0
01-1/2-591	14,0	78	21,0	24,0
01-1/2-592	16,0	78	23,0	24,0
01-1/2-593	17,0	78	24,0	24,0
01-1/2-594	18,0	78	25,0	25,0
01-1/2-595	19,0	78	26,0	26,0
01-1/2-596	21,0	78	28,0	28,0
01-1/2-597	22,0	78	29,5	29,5

Potrzebujesz inne długości?

Zrobimy je dla Ciebie
w możliwym dla nas zakresie

L [mm]

50 min 240 max

NASADKI CIENKOŚCIENNE

Specjalne nasadki udarowe pozwalające na pracę w ciężkich warunkach (gdzie standardowe nasadki się nie mieszczą).
Zalecane dla do profesjonalnych serwisów ogumienia oraz samochodowych

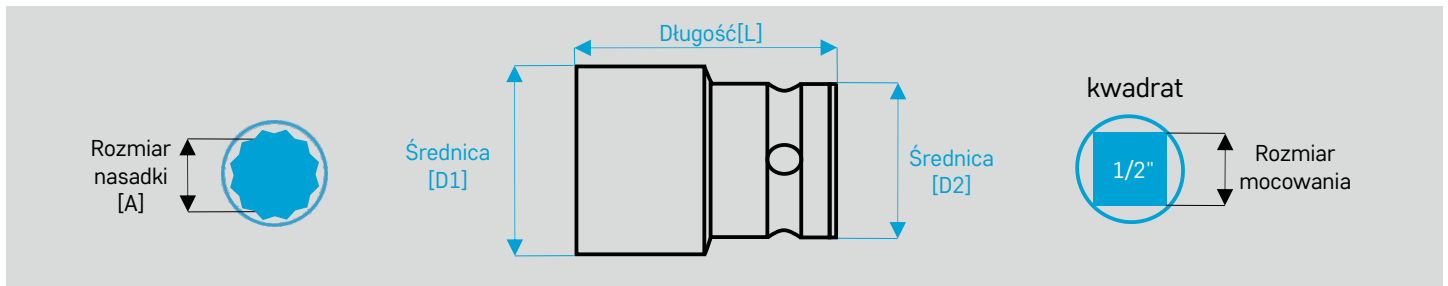

Nasadki udarowe 12-kątne
double hexagon
- krótka wersja cienkościenne



Kod	A [mm]	L [mm]	D1 [mm]	D2 [mm]
01-1/2-628	10,0	38	15,5	22,0
01-1/2-629	11,0	38	16,7	22,0
01-1/2-630	12,0	38	18,0	22,0
01-1/2-631	13,0	38	19,2	22,0
01-1/2-632	14,0	38	21,0	24,0
01-1/2-633	15,0	38	21,7	24,0
01-1/2-634	16,0	38	23,0	24,0
01-1/2-635	17,0	38	24,0	24,0
01-1/2-636	18,0	38	25,0	25,0
01-1/2-637	19,0	38	26,0	26,0
01-1/2-638	21,0	38	29,5	28,0
01-1/2-639	22,0	38	30,9	29,5

Potrzebujesz inne długości?

Zrobimy je dla Ciebie
w możliwym dla nas zakresie

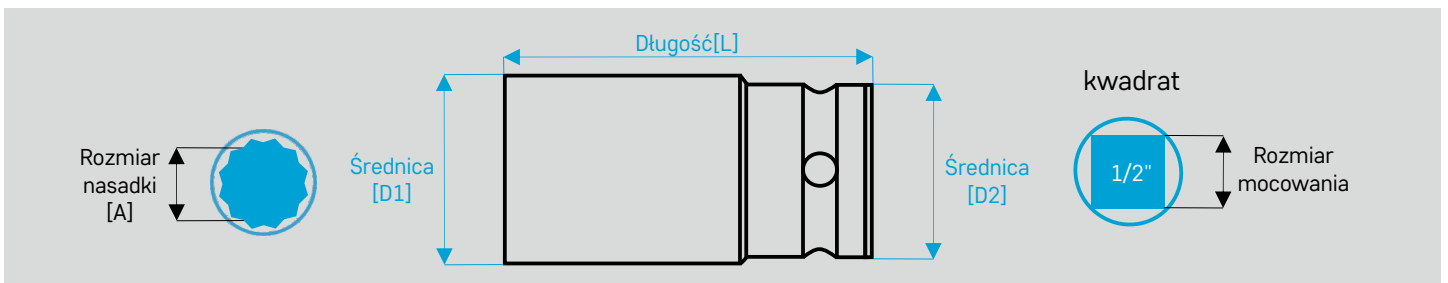

Nasadki udarowe 12-kątne
double hexagon
- dłuższa wersja cienkościenne



Kod	A [mm]	L [mm]	D1 [mm]	D2 [mm]
01-1/2-660	10,0	78	15,5	22,0
01-1/2-661	13,0	78	19,2	24,0
01-1/2-662	14,0	78	21,0	24,0
01-1/2-663	16,0	78	23,0	24,0
01-1/2-664	17,0	78	24,0	24,0
01-1/2-665	18,0	78	25,0	25,0
01-1/2-666	19,0	78	26,0	26,0
01-1/2-667	21,0	78	28,0	28,0
01-1/2-668	22,0	78	29,5	29,5

Potrzebujesz inne długości?

Zrobimy je dla Ciebie
w możliwym dla nas zakresie

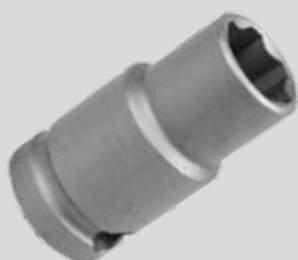

NASADKI CIENKOŚCIENNE

Specjalne nasadki udarowe pozwalające na pracę w ciężkich warunkach
(gdzie standardowe nasadki się nie mieszczą).

Zalecane dla do profesjonalnych serwisów ogumienia oraz samochodowych

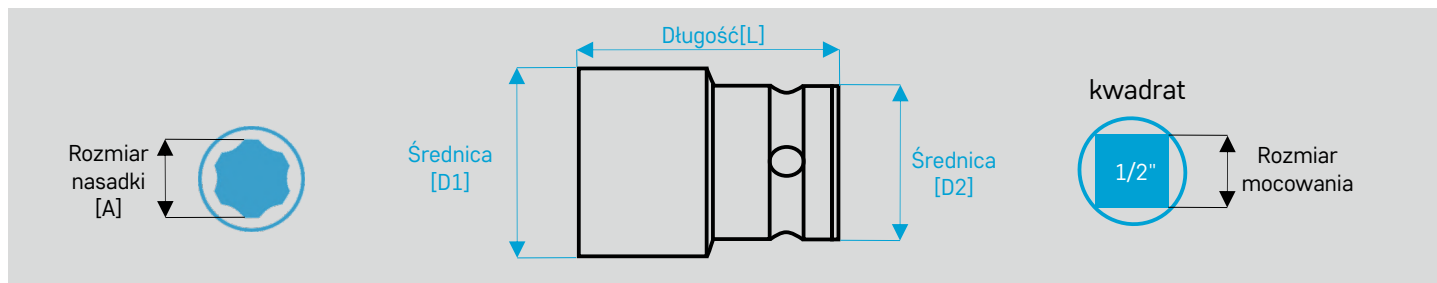

Nasadki udarowe 6-kątne hexagon Surface Drive TORX® PLUS cienkościenne



Kod	A [mm]	L [mm]	D1 [mm]	D2 [mm]
01-1/2-689	10,0	38	15,5	22,0
01-1/2-690	11,0	38	16,7	22,0
01-1/2-691	13,0	38	19,2	22,0
01-1/2-692	14,0	38	21,0	24,0
01-1/2-693	15,0	38	21,7	24,0
01-1/2-694	16,0	38	23,0	24,0
01-1/2-695	17,0	38	24,0	24,0
01-1/2-696	18,0	38	25,0	25,0
01-1/2-697	19,0	38	26,0	26,0
01-1/2-698	21,0	38	29,5	28,0
01-1/2-699	22,0	38	30,9	29,5

Potrzebujesz inne długości?

Zrobimy je dla Ciebie w możliwym dla nas zakresie

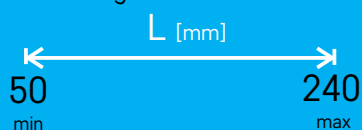

Nasadki udarowe 6-kątne hex. Surface Drive TORX® PLUS cienkościenne - wersja dłuższa



Kod	A [mm]	L [mm]	D1 [mm]	D2 [mm]
01-1/2-720	10,0	78	15,5	22,0
01-1/2-721	12,0	78	18,0	22,0
01-1/2-722	13,0	78	19,2	24,0
01-1/2-723	14,0	78	21,0	24,0
01-1/2-724	15,0	78	21,7	24,0
01-1/2-725	16,0	78	23,0	24,0
01-1/2-726	17,0	78	24,0	24,0
01-1/2-727	18,0	78	25,0	25,0

Potrzebujesz inne długości?

Zrobimy je dla Ciebie w możliwym dla nas zakresie

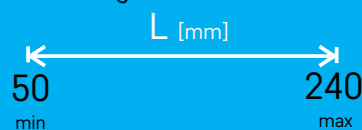

NASADKI TORX®
GWARANTUJEMY
WYTRZYMAŁOŚĆ I TRWAŁOŚĆ

Potrzebujesz czegoś więcej? Dla nas to żaden problem!

24 Możemy wyprodukować narzędzia specjalne dostosowane do Twoich indywidualnych potrzeb.

01 Nasadki udarowe 1/2"

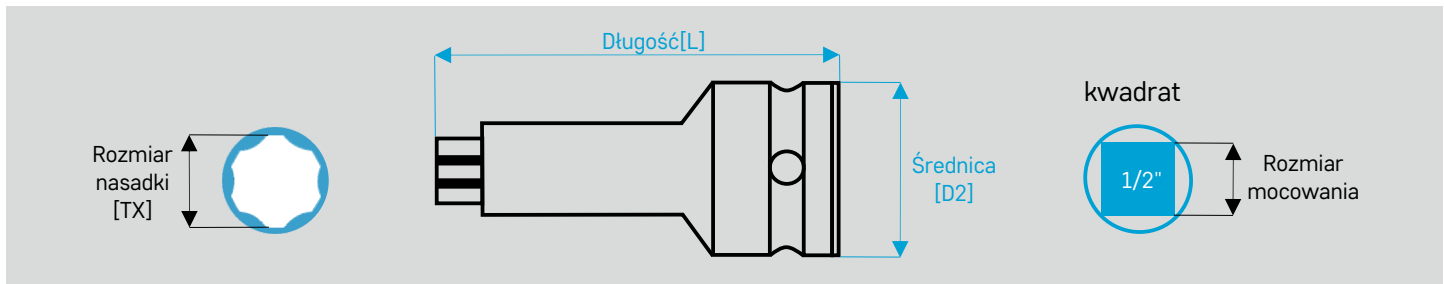

Nasadki wkrętaskowe TORX® PLUS
socket screws



Kod	TX [mm]	L [mm]	D2 [mm]
01-1/2-748	30,0	55	25,0
01-1/2-749	40,0	55	25,0
01-1/2-750	50,0	55	25,0
01-1/2-751	55,0	55	25,0
01-1/2-752	60,0	55	25,0

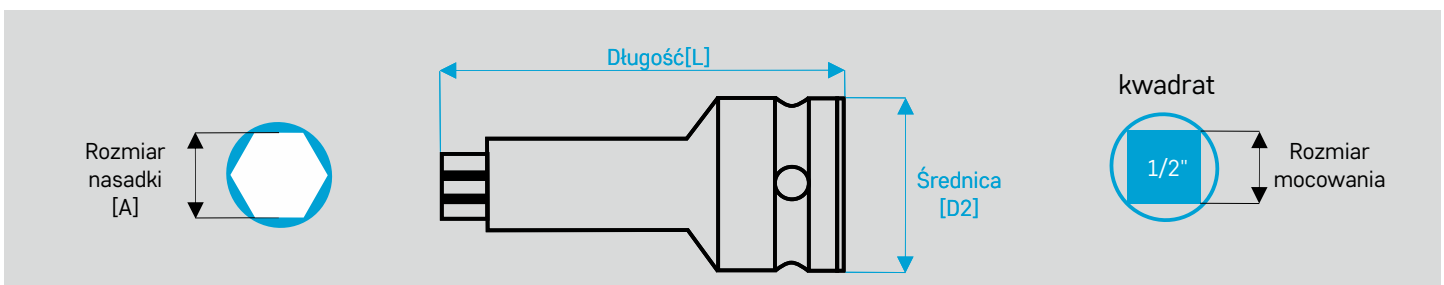

Nasadki wkrętaskowe 6-kątne hexagon



Kod	TX [mm]	L [mm]	D2 [mm]
01-1/2-773	4,0	55	25,0
01-1/2-774	5,0	55	25,0
01-1/2-775	6,0	55	25,0
01-1/2-776	8,0	55	25,0
01-1/2-777	10,0	55	25,0
01-1/2-778	12,0	55	25,0
01-1/2-779	14,0	55	25,0
01-1/2-780	17,0	55	25,0
01-1/2-781	18,0	55	25,0
01-1/2-782	19,0	55	25,0

Potrzebujesz inne długości?

Zrobimy je dla Ciebie
w możliwym dla nas zakresie

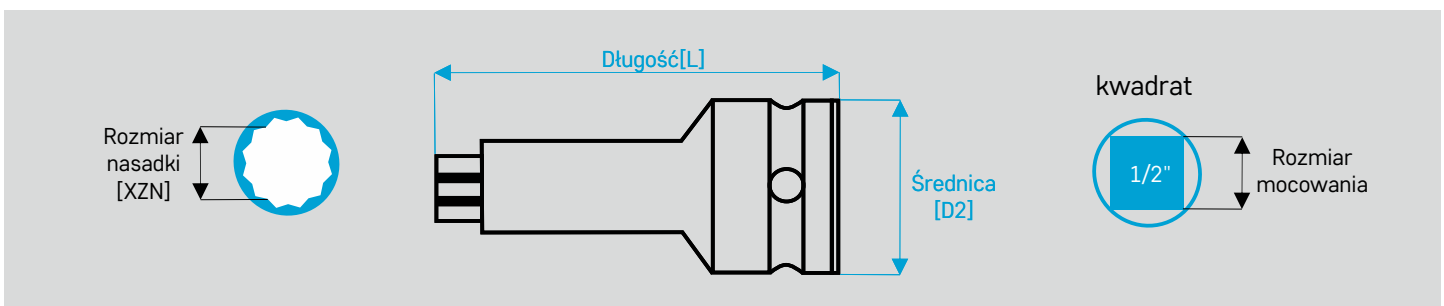
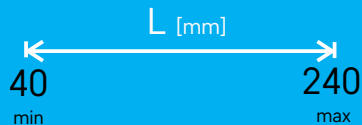

Nasadki wkrętaskowe XZN



Potrzebujesz inne długości?

Zrobimy je dla Ciebie
w możliwym dla nas zakresie

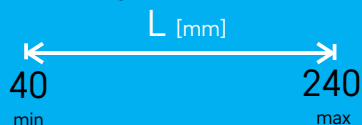

Kod	XZN [mm]	L [mm]	D2 [mm]
01-1/2-800	M5	55	25,0
01-1/2-801	M6	55	25,0
01-1/2-802	M8	55	25,0
01-1/2-803	M10	55	25,0
01-1/2-804	M12	55	25,0
01-1/2-805	M14	55	25,0

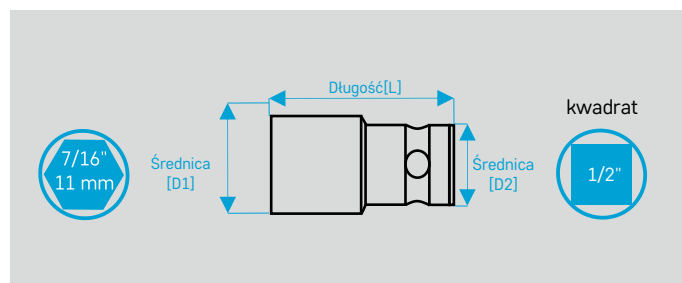
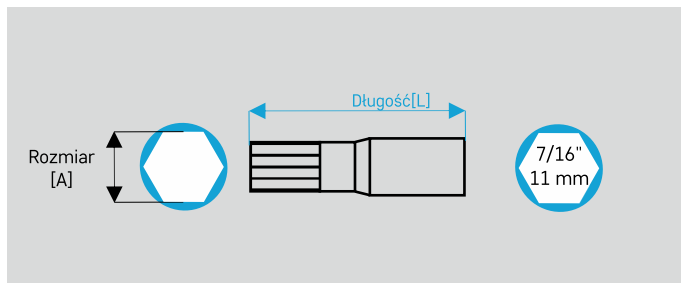

Końcówki imbusowe 7/16" - 11 mm

Kod	A [mm]	L [mm]
01-7/16-038	5,0	35,0
01-7/16-039	6,0	35,0
01-7/16-040	8,0	35,0
01-7/16-041	10,0	35,0
01-7/16-042	12,0	35,0
01-7/16-043	14,0	35,0
01-7/16-044	17,0	35,0



Adaptory 6-kątne hexagon 7/16" - 11 mm

Kod	L [mm]	D1 [mm]	D2 [mm]
01-1/2-826	38	22,0	30,0

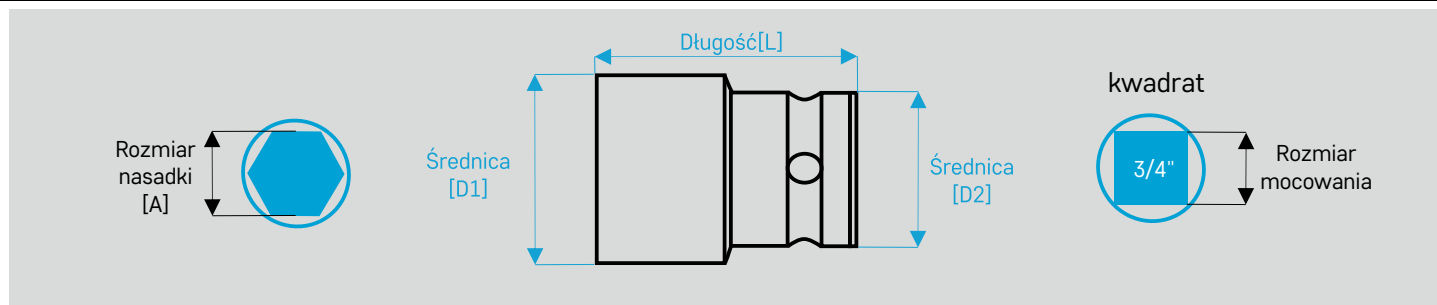

Nasadki udarowe 6-kątne hexagon



Kod	A [mm]	L [mm]	D1 [mm]	D2 [mm]
01-3/4-011	16,0	50	27,0	44
01-3/4-012	17,0	50	31,0	44
01-3/4-013	18,0	50	32,0	44
01-3/4-014	19,0	50	33,0	44
01-3/4-015	20,0	50	34,0	44
01-3/4-016	21,0	50	35,0	44
01-3/4-017	22,0	50	37,0	44
01-3/4-018	23,0	50	38,0	44
01-3/4-019	24,0	50	39,0	44
01-3/4-020	25,0	50	40,0	44
01-3/4-021	27,0	54	43,0	44
01-3/4-022	30,0	54	47,0	44
01-3/4-023	32,0	56	49,0	44
01-3/4-024	33,0	56	51,0	44
01-3/4-025	34,0	56	52,0	44
01-3/4-026	35,0	56	53,0	44
01-3/4-027	36,0	56	54,0	44
01-3/4-028	38,0	58	57,0	44
01-3/4-029	39,0	58	58,0	44
01-3/4-030	41,0	58	60,0	44
01-3/4-031	42,0	58	62,0	44
01-3/4-032	46,0	63	67,0	44
01-3/4-033	50,0	72	71,0	54
01-3/4-034	55,0	74	77,0	54
01-3/4-035	60,0	75	84,0	54

Potrzebujesz inne długości takich nasadek?

Zrobimy je dla Ciebie nasadki na zamówienie w możliwym dla nas zakresie

L [mm]
50 min 240 max

Potrzebujesz czegoś więcej? Dla nas to żaden problem!

26 Możemy wyprodukować narzędzia specjalne dostosowane do Twoich indywidualnych potrzeb.

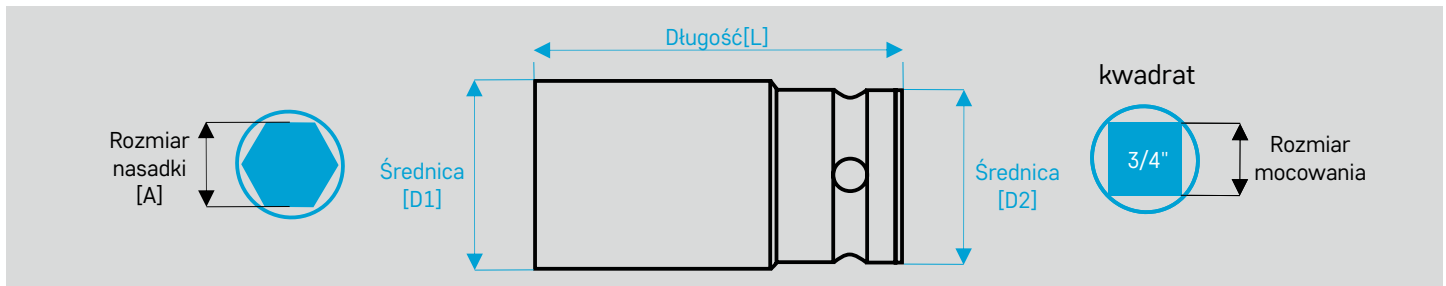

Nasadki udarowe 6-kątne hexagon - dłuższa wersja



Kod	A [mm]	L [mm]	D1 [mm]	D2 [mm]
01-3/4-056	16,0	95	27,0	44
01-3/4-057	17,0	95	31,0	44
01-3/4-058	18,0	95	32,0	44
01-3/4-059	19,0	95	33,0	44
01-3/4-060	21,0	95	35,0	44
01-3/4-061	22,0	95	37,0	44
01-3/4-062	24,0	95	39,0	44
01-3/4-063	27,0	95	43,0	44
01-3/4-064	30,0	95	47,0	44
01-3/4-065	32,0	95	49,0	44
01-3/4-066	33,0	95	51,0	44
01-3/4-067	34,0	95	52,0	44
01-3/4-068	36,0	95	54,0	44
01-3/4-069	38,0	95	57,0	44
01-3/4-070	39,0	95	58,0	44
01-3/4-071	41,0	95	60,0	44
01-3/4-072	46,0	95	67,0	44
01-3/4-073	50,0	95	71,0	54

Nasadki udarowe 6-kątne hexagon - wersja bardzo długa (XL)



Kod	A [mm]	L [mm]	D1 [mm]	D2 [mm]
01-3/4-094	24,0	270	38,9	44
01-3/4-095	27,0	270	42,5	44
01-3/4-096	30,0	270	46,5	44
01-3/4-097	32,0	270	48,8	44
01-3/4-098	33,0	270	50,0	44
01-3/4-099	36,0	270	53,8	44

Nasadki udarowe 6-kątne hexagon - dłuższa wersja cieńkościenne



Kod	A [mm]	L [mm]	D1 [mm]	D2 [mm]
01-3/4-120	19,0	95	28,5	44,0
01-3/4-121	22,0	95	33,5	44,0
01-3/4-122	24,0	95	36,5	44,0
01-3/4-123	27,0	95	40,5	44,0
01-3/4-124	30,0	95	43,5	44,0
01-3/4-125	32,0	95	46,5	44,0
01-3/4-126	36,0	95	52,0	44,0

Potrzebujesz inne długości takich nasadek?

Zrobimy je dla Ciebie na zamówienie w możliwym dla nas zakresie



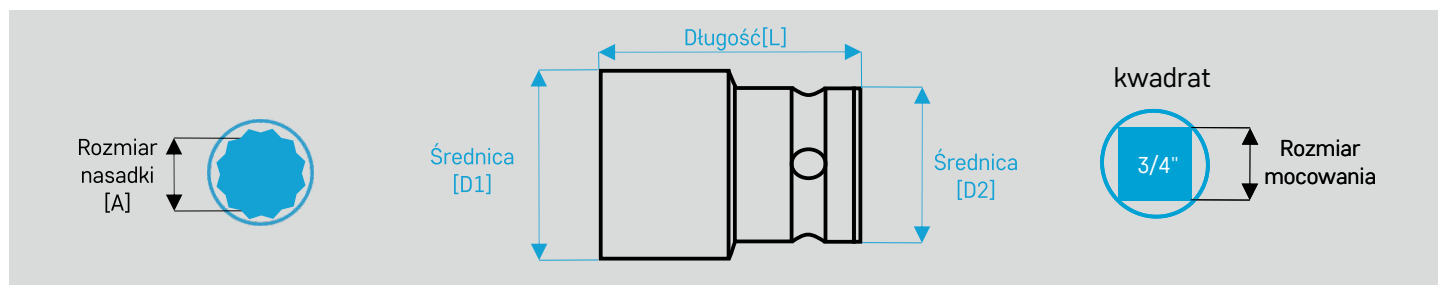

Nasadki udarowe
12-kątne double hexagon



Kod	A [mm]	L [mm]	D1 [mm]	D2 [mm]
01-3/4-147	16,0	50	27,0	44
01-3/4-148	17,0	50	31,0	44
01-3/4-149	18,0	50	32,0	44
01-3/4-150	19,0	50	33,0	44
01-3/4-151	20,0	50	34,0	44
01-3/4-152	21,0	50	35,0	44
01-3/4-153	22,0	50	37,0	44
01-3/4-154	23,0	50	38,0	44
01-3/4-155	24,0	50	39,0	44
01-3/4-156	25,0	50	40,0	44
01-3/4-157	27,0	54	43,0	44
01-3/4-158	30,0	54	47,0	44
01-3/4-159	32,0	56	49,0	44
01-3/4-160	33,0	56	51,0	44
01-3/4-161	34,0	56	52,0	44
01-3/4-162	35,0	56	53,0	44
01-3/4-163	36,0	56	54,0	44
01-3/4-164	38,0	58	57,0	44
01-3/4-165	39,0	58	58,0	44
01-3/4-166	41,0	58	60,0	44
01-3/4-167	42,0	58	62,0	44
01-3/4-168	46,0	63	67,0	44
01-3/4-169	50,0	72	71,0	54
01-3/4-170	55,0	74	77,0	54
01-3/4-171	60,0	75	84,0	54

Potrzebujesz inne długości
takich nasadek?

Zrobimy je dla Ciebie
na zamówienie
w możliwym dla nas zakresie



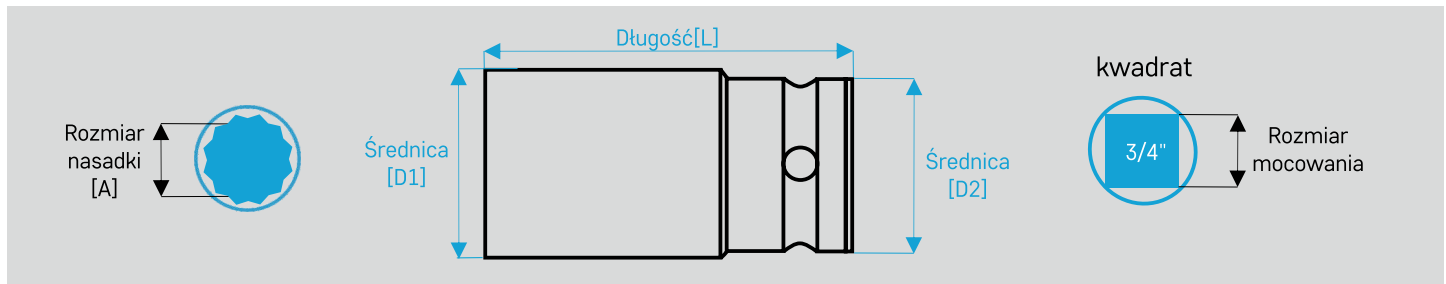

Nasadki udarowe 12-kątne double hexagon - dłuższa wersja



Kod	A [mm]	L [mm]	D1 [mm]	D2 [mm]
01-3/4-192	16,0	95	27,0	44
01-3/4-193	17,0	95	31,0	44
01-3/4-194	18,0	95	32,0	44
01-3/4-195	19,0	95	33,0	44
01-3/4-196	21,0	95	35,0	44
01-3/4-197	22,0	95	37,0	44
01-3/4-198	24,0	95	39,0	44
01-3/4-199	27,0	95	43,0	44
01-3/4-200	30,0	95	47,0	44
01-3/4-201	32,0	95	49,0	44
01-3/4-202	33,0	95	51,0	44
01-3/4-203	34,0	95	52,0	44
01-3/4-204	36,0	95	54,0	44
01-3/4-205	38,0	95	57,0	44
01-3/4-206	39,0	95	58,0	44
01-3/4-207	41,0	95	60,0	44
01-3/4-208	46,0	95	67,0	44
01-3/4-209	50,0	95	71,0	54

Nasadki udarowe 12-kątne double hexagon - wersja bardzo długa (XL)



Kod	A [mm]	L [mm]	D1 [mm]	D2 [mm]
01-3/4-220	24,0	270	38,9	44
01-3/4-221	27,0	270	42,5	44
01-3/4-222	30,0	270	46,5	44
01-3/4-223	32,0	270	48,8	44
01-3/4-224	33,0	270	50,0	44
01-3/4-225	36,0	270	53,8	44

Nasadki udarowe 12-kątne double hexagon dłuższa wersja cienkościenne



Kod	A [mm]	L [mm]	D1 [mm]	D2 [mm]
01-3/4-246	19,0	95	28,5	44,0
01-3/4-247	22,0	95	33,5	44,0
01-3/4-248	24,0	95	36,5	44,0
01-3/4-249	27,0	95	40,5	44,0
01-3/4-250	30,0	95	43,5	44,0
01-3/4-251	32,0	95	46,5	44,0
01-3/4-252	36,0	95	52,0	44,0

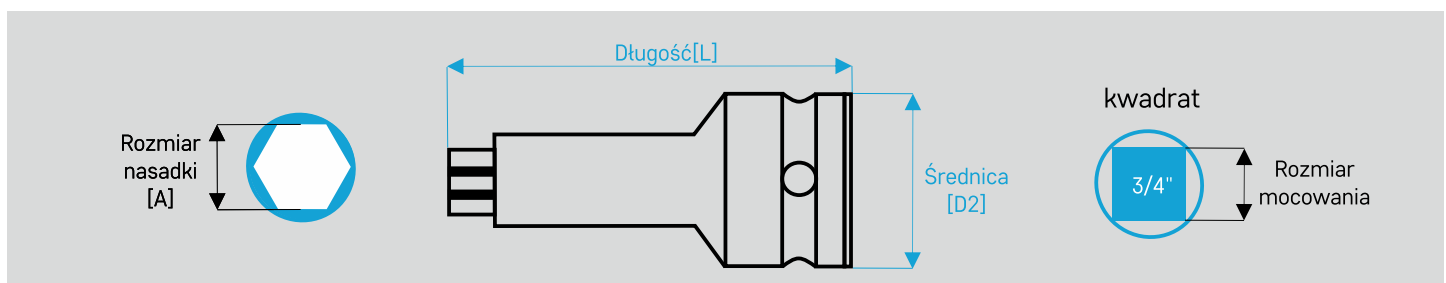

Nasadki wkrętakowe 6-kątne hexagon



Potrzebujesz inne długości?

Zrobimy je dla Ciebie w możliwym dla nas zakresie

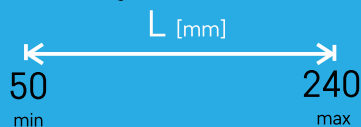

Kod	A [mm]	L [mm]	D2 [mm]
01-3/4-273	12,0	62	44,0
01-3/4-274	14,0	62	44,0
01-3/4-275	17,0	62	44,0
01-3/4-276	19,0	62	44,0
01-3/4-277	22,0	62	44,0
01-3/4-278	24,0	62	44,0
01-3/4-279	27,0	62	44,0
01-3/4-280	30,0	62	44,0
01-3/4-281	32,0	62	44,0

01 Nasadki udarowe 3/4"

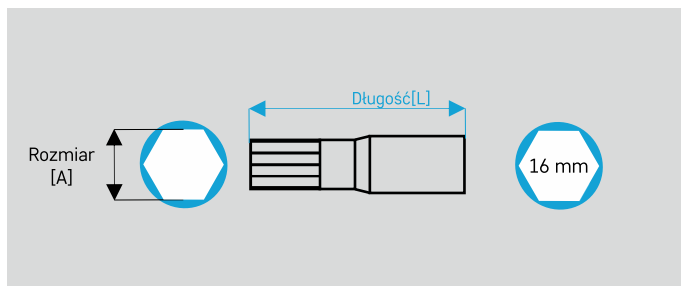

Końcówki imbusowe 16 mm

Kod	A [mm]	L [mm]
01-16-011	10	40,0
01-16-012	12	40,0
01-16-013	14	40,0
01-16-014	17	40,0
01-16-015	19	40,0
01-16-016	22	40,0
01-16-017	24	40,0

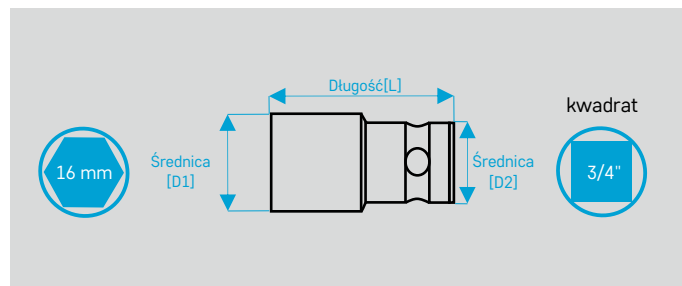

Adaptory 6-kątne hexagon 16 mm

Kod	L [mm]	D1 [mm]	D2 [mm]
01-3/4-302	52	32,0	44,0



01 Nasadki udarowe 1"

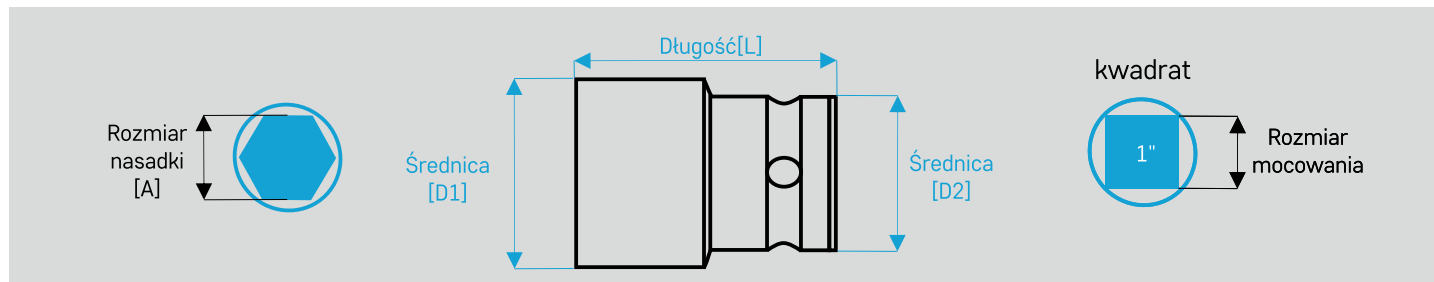

Nasadki udarowe 6-kątne hexagon



Kod	A [mm]	L [mm]	D1 [mm]	D2 [mm]
01-1-011	19,0	58	35,5	54
01-1-012	21,0	58	37,5	54
01-1-013	22,0	55	40,0	54
01-1-014	24,0	55	42,0	54
01-1-015	27,0	55	46,0	54
01-1-016	28,0	58	47,0	54
01-1-017	29,0	60	48,0	54
01-1-018	30,0	57	50,0	54
01-1-019	32,0	57	52,0	54
01-1-020	33,0	57	53,0	54
01-1-021	34,0	60	55,0	54
01-1-022	36,0	60	56,0	54
01-1-023	38,0	64	59,0	54
01-1-024	39,0	67	60,0	54
01-1-025	41,0	64	64,0	54
01-1-026	46,0	69	69,5	54
01-1-027	50,0	72	74,0	54
01-1-028	55,0	76	80,0	54
01-1-029	60,0	82	86,0	54
01-1-030	65,0	85	92,0	54
01-1-031	70,0	88	99,0	54
01-1-032	75,0	92	104,0	86
01-1-033	80,0	97	109,0	86
01-1-034	85,0	100	115,0	86
01-1-035	90,0	105	119,0	86
01-1-036	95,0	105	130,0	86
01-1-037	100,0	105	136,0	95

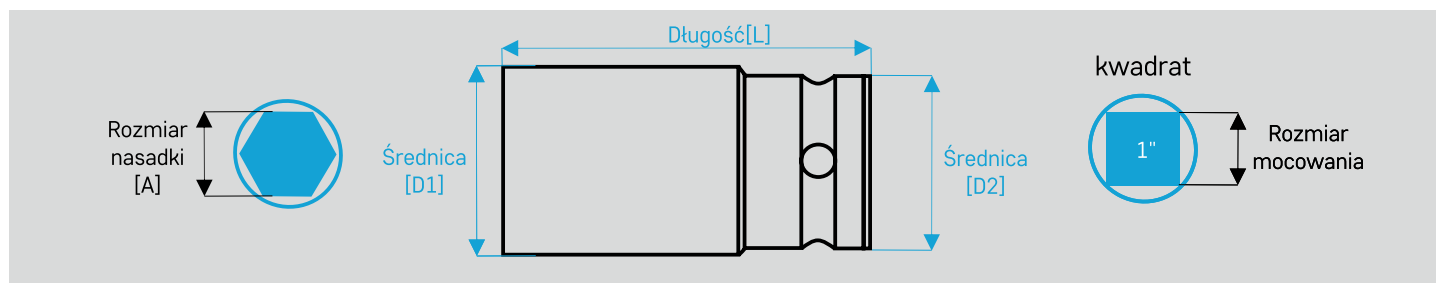

Nasadki udarowe 6-kątne hexagon
- dłuższa wersja

Kod	A [mm]	L [mm]	D1 [mm]	D2 [mm]
01-1-058	19,0	100	35,5	54
01-1-059	22,0	100	40,0	54
01-1-060	23,0	100	41,0	54
01-1-061	24,0	100	42,0	54
01-1-062	27,0	100	46,0	54
01-1-063	30,0	100	50,0	54
01-1-064	32,0	100	52,0	54
01-1-065	33,0	100	53,0	54
01-1-066	34,0	100	55,0	54
01-1-067	36,0	100	57,0	54
01-1-068	38,0	100	59,5	54
01-1-069	39,0	100	60,0	54
01-1-070	41,0	100	64,0	54
01-1-071	46,0	100	69,5	54
01-1-072	50,0	100	75,0	54
01-1-073	55,0	100	81,0	54
01-1-074	60,0	105	87,0	54
01-1-075	65,0	125	93,0	54
01-1-076	70,0	125	99,0	54
01-1-077	75,0	135	104,0	86
01-1-078	80,0	135	109,0	86

Nasadki udarowe 6-kątne hexagon
- dłuższa wersja cieńkościenne

Kod	A [mm]	L [mm]	D1 [mm]	D2 [mm]
01-1-099	22,0	108	36,0	53,0
01-1-100	24,0	108	38,5	53,0
01-1-101	27,0	108	42,3	53,0
01-1-102	30,0	108	46,0	53,0
01-1-103	32,0	108	48,5	53,0
01-1-104	33,0	108	49,8	53,0
01-1-105	36,0	108	53,5	53,0

Nasadki udarowe 6-kątne hexagon
- wersja bardzo długa (XL)

Kod	A [mm]	L [mm]	D1 [mm]	D2 [mm]
01-1-126	24,0	270	38,5	54
01-1-127	27,0	270	42,3	54
01-1-128	30,0	270	46,0	54
01-1-129	32,0	270	48,5	54
01-1-130	33,0	270	49,8	54
01-1-131	36,0	270	53,5	54

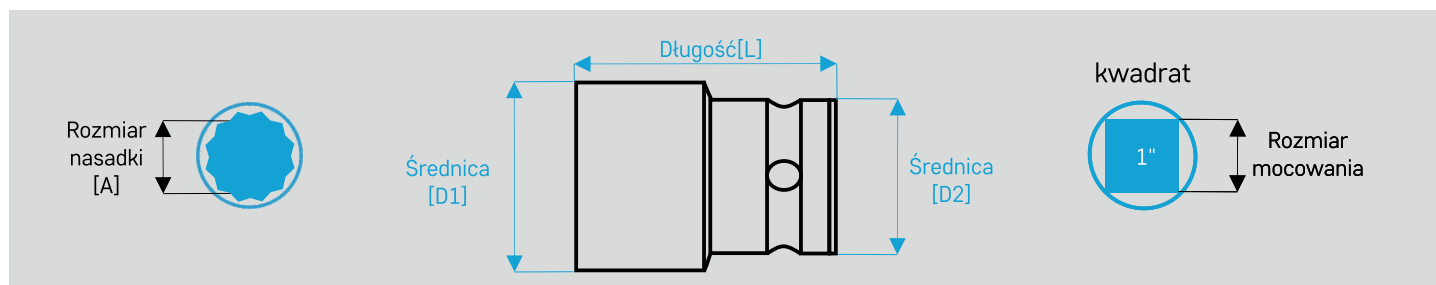

Nasadki udarowe
12-kątne double hexagon



Kod	A [mm]	L [mm]	D1 [mm]	D2 [mm]
01-1-152	19,0	58	35,5	54
01-1-153	21,0	58	37,5	54
01-1-154	22,0	55	40,0	54
01-1-155	24,0	55	42,0	54
01-1-156	27,0	55	46,0	54
01-1-157	28,0	58	47,0	54
01-1-158	29,0	60	48,0	54
01-1-159	30,0	57	50,0	54
01-1-160	32,0	57	52,0	54
01-1-161	33,0	57	53,0	54
01-1-162	34,0	60	55,0	54
01-1-163	36,0	60	56,0	54
01-1-164	38,0	64	59,0	54
01-1-165	39,0	67	60,0	54
01-1-166	41,0	64	64,0	54
01-1-167	46,0	69	69,5	54
01-1-168	50,0	72	74,0	54
01-1-169	55,0	76	80,0	54
01-1-170	60,0	82	86,0	54
01-1-171	65,0	85	92,0	54
01-1-172	70,0	88	99,0	54
01-1-173	75,0	92	104,0	86
01-1-174	80,0	97	109,0	86
01-1-175	85,0	100	115,0	86
01-1-176	90,0	105	119,0	86
01-1-177	95,0	105	130,0	86
01-1-178	100,0	105	136,0	95

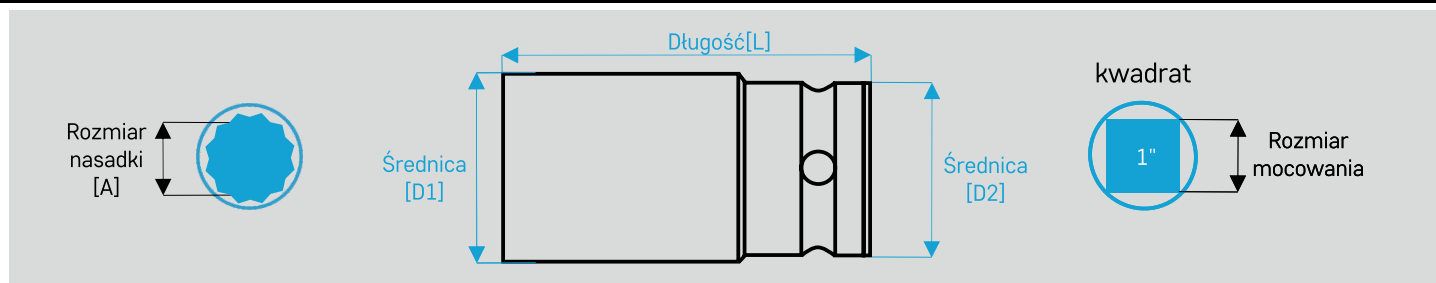

Nasadki udarowe 12-kątne double hexagon - dłuższa wersja



Kod	A [mm]	L [mm]	D1 [mm]	D2 [mm]
01-1-199	19,0	100	35,5	54
01-1-200	22,0	100	40,0	54
01-1-201	23,0	100	41,0	54
01-1-202	24,0	100	42,0	54
01-1-203	27,0	100	46,0	54
01-1-204	30,0	100	50,0	54
01-1-205	32,0	100	52,0	54
01-1-206	33,0	100	53,0	54
01-1-207	34,0	100	55,0	54
01-1-208	36,0	100	57,0	54
01-1-209	38,0	100	59,5	54
01-1-210	39,0	100	60,0	54
01-1-211	41,0	100	64,0	54
01-1-212	46,0	100	69,5	54
01-1-213	50,0	100	75,0	54
01-1-214	55,0	100	81,0	54
01-1-215	60,0	105	87,0	54
01-1-216	65,0	125	93,0	54
01-1-217	70,0	125	99,0	54
01-1-218	75,0	135	104,0	86
01-1-219	80,0	135	109,0	86

Nasadki udarowe 12-kątne double hexagon - wersja bardzo długa (XL)



Kod	A [mm]	L [mm]	D1 [mm]	D2 [mm]
01-1-240	22,0	108	36,0	53,0
01-1-241	24,0	108	38,5	53,0
01-1-242	27,0	108	42,3	53,0
01-1-243	30,0	108	46,0	53,0
01-1-244	32,0	108	48,5	53,0
01-1-245	33,0	108	49,8	53,0
01-1-246	36,0	108	53,5	53,0

Nasadki udarowe 6-kątne hexagon - dłuższa wersja cieńkościenne



Kod	A [mm]	L [mm]	D1 [mm]	D2 [mm]
01-1-267	24,0	270	38,5	54
01-1-268	27,0	270	42,3	54
01-1-269	30,0	270	46,0	54
01-1-270	32,0	270	48,5	54
01-1-271	33,0	270	49,8	54
01-1-272	36,0	270	53,5	54

TWOJE STANOWISKO NASZE PIANKI

Niezależnie od branży, w której działasz,

Twoje narzędzia wymagają bezpiecznego przechowywania i odpowiedniej segregacji.

Możemy stworzyć pianki, które są dostępne w różnych kolorach, mogą zawierać specjalne oznaczenia narzędzi, które jeszcze bardziej ułatwią Ci pracę.

Możemy je również dla Ciebie spersonalizować, np. dodając Twoje logo!



Wkładki piankowe dla narzędzi są niezbędne do zwiększenia ich wydajności i organizacji w miejscu pracy. Oto niektóre z zalet pianek do narzędzi i ich segregacji:

- >> **ochrona narzędzi:** idealnie dopasowane pianki zapewniają ochronę przed uszkodzeniami, wstrząsami, zarysowaniami i korozją, utrzymując narzędzia w idealnym stanie przez długi czas,
- >> **łatwość organizacji:** ułatwiają organizację i przechowywanie narzędzi, dzięki czemu można utrzymać porządek w warsztacie, szafce czy torbie narzędziowej; dzięki właściwej segregacji można szybko znaleźć potrzebny narzędzie bez konieczności przeszukiwania całego zaplecza,
- >> **zwiększenie trwałości narzędzi:** przyczyniają się do zwiększenia trwałości narzędzi poprzez zabezpieczenie ich przed uszkodzeniami mechanicznymi i środowiskowymi, co przekłada się na dłuższy okres eksploatacji.

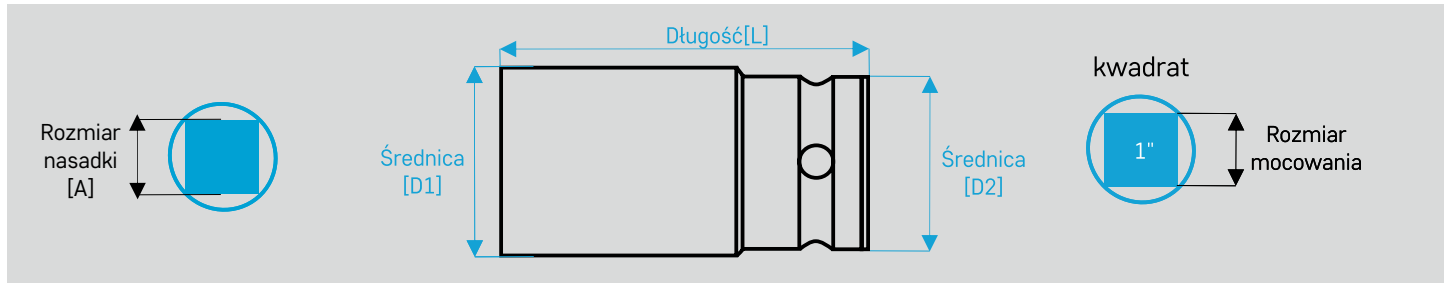

Nasadki udarowe kwadrat



Kod	A [mm]	L [mm]	D1 [mm]	D2 [mm]
01-1-293	21x28	108	53,0	54

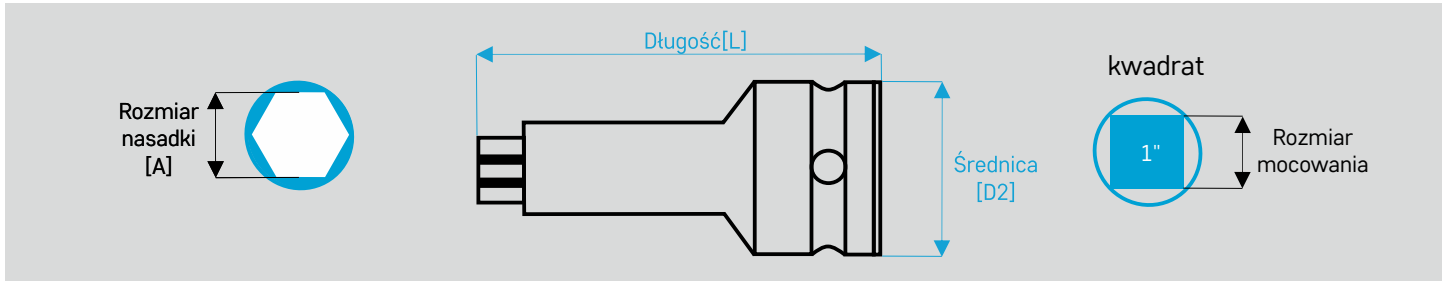

Nasadki wkrętakowe 6-kątne hexagon



Kod	A [mm]	L [mm]
01-1-314	14,0	75
01-1-315	17,0	75
01-1-316	19,0	75
01-1-317	22,0	75
01-1-318	24,0	75
01-1-319	27,0	75
01-1-320	30,0	75
01-1-321	32,0	75
01-1-322	36,0	75

Potrzebujesz inne długości?

Zrobimy je dla Ciebie
w możliwym dla nas zakresie

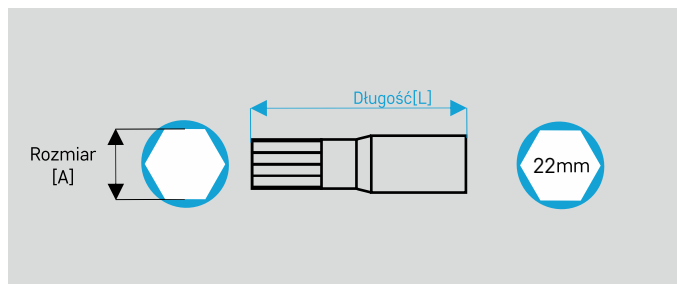

Końcówki imbusowe 22mm

Kod	A [mm]	L [mm]
01-22-011	14	50,0
01-22-012	17	50,0
01-22-013	19	50,0
01-22-014	22	50,0
01-22-015	24	50,0
01-22-016	27	50,0
01-22-017	30	50,0
01-22-018	32	50,0
01-22-019	36	50,0

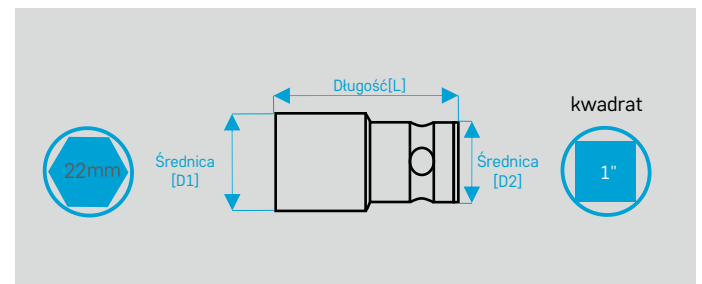

Adaptory 6-kątne hexagon 22mm

Kod	L [mm]	D1 [mm]	D2 [mm]
01-1-343	70	44,0	54,0



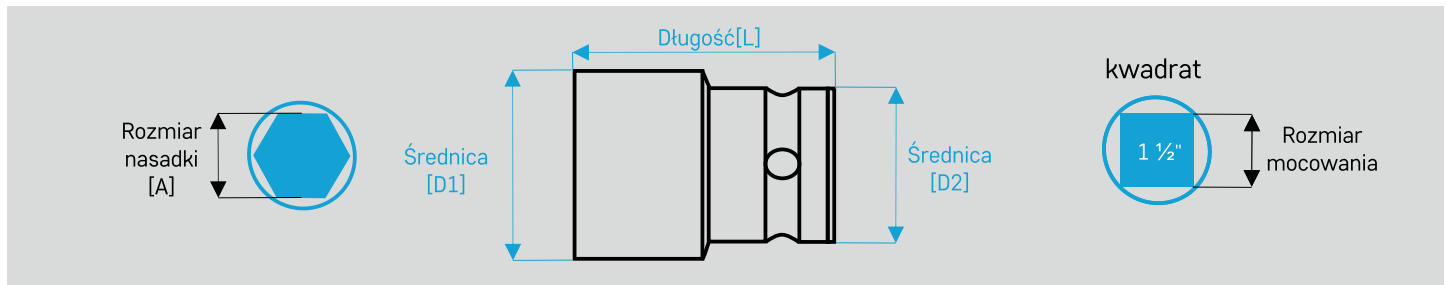

Nasadki udarowe 6-kątne hexagon



Kod	A [mm]	L [mm]	D1 [mm]	D2 [mm]
01-1,1/2-011	36,0	78	64,0	86
01-1,1/2-012	41,0	80	70,0	86
01-1,1/2-013	42,0	80	71,0	86
01-1,1/2-014	46,0	84	76,0	86
01-1,1/2-015	50,0	87	81,0	86
01-1,1/2-016	55,0	90	86,0	86
01-1,1/2-017	60,0	92	93,0	86
01-1,1/2-018	65,0	95	97,0	86
01-1,1/2-019	70,0	100	105,0	86
01-1,1/2-020	75,0	103	110,0	86
01-1,1/2-021	80,0	110	116,0	86
01-1,1/2-022	85,0	118	125,0	86
01-1,1/2-023	90,0	118	130,0	86
01-1,1/2-024	95,0	118	137,0	95
01-1,1/2-025	100,0	125	140,0	95
01-1,1/2-026	105,0	125	150,0	95
01-1,1/2-027	110,0	125	156,0	95
01-1,1/2-028	115,0	135	160,0	95
01-1,1/2-029	120,0	135	168,0	95
01-1,1/2-030	125,0	135	175,0	95

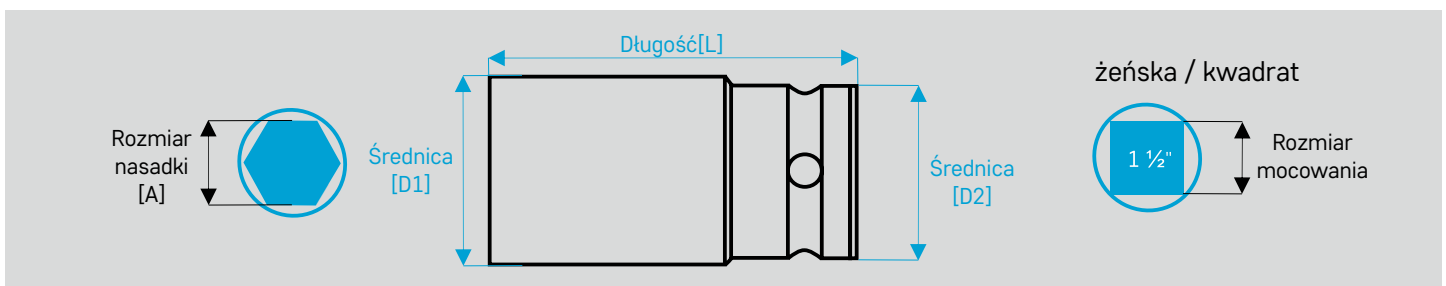

Nasadki udarowe 6-kątne hexagon
- dłuższa wersja



Kod	A [mm]	L [mm]	D1 [mm]	D2 [mm]
01-1,1/2-051	41,0	115	70,0	86
01-1,1/2-052	46,0	115	78,0	86
01-1,1/2-053	50,0	135	81,0	86
01-1,1/2-054	55,0	140	86,0	86
01-1,1/2-055	60,0	150	94,0	86
01-1,1/2-056	65,0	150	100,0	86
01-1,1/2-057	70,0	160	105,0	86
01-1,1/2-058	75,0	170	110,0	86
01-1,1/2-059	80,0	170	116,0	86
01-1,1/2-060	85,0	170	125,0	86
01-1,1/2-061	90,0	175	128,0	86

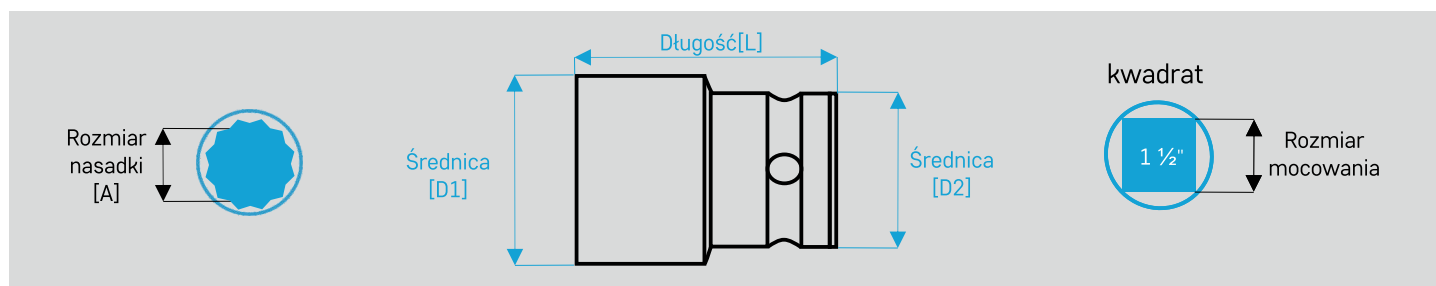

Nasadki udarowe
12-kątne double hexagon



Kod	A [mm]	L [mm]	D1 [mm]	D2 [mm]
01-1,1/2-082	36,0	78	64,0	86
01-1,1/2-083	41,0	80	70,0	86
01-1,1/2-084	42,0	80	71,0	86
01-1,1/2-085	46,0	84	76,0	86
01-1,1/2-086	50,0	87	81,0	86
01-1,1/2-087	55,0	90	86,0	86
01-1,1/2-088	60,0	92	93,0	86
01-1,1/2-089	65,0	95	97,0	86
01-1,1/2-090	70,0	100	105,0	86
01-1,1/2-091	75,0	103	110,0	86
01-1,1/2-092	80,0	110	116,0	86
01-1,1/2-093	85,0	118	125,0	86
01-1,1/2-094	90,0	118	130,0	86
01-1,1/2-095	95,0	118	137,0	95
01-1,1/2-096	100,0	125	140,0	95
01-1,1/2-097	105,0	125	150,0	95
01-1,1/2-098	110,0	125	156,0	95
01-1,1/2-099	115,0	135	160,0	95
01-1,1/2-100	120,0	135	168,0	95
01-1,1/2-101	125,0	135	175,0	95

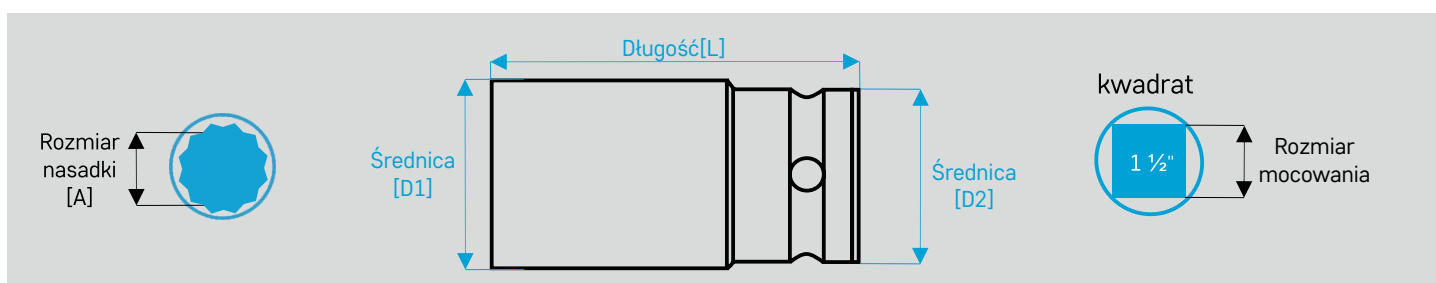

Nasadki udarowe
12-kątne double hexagon
- dłuższa wersja



Kod	A [mm]	L [mm]	D1 [mm]	D2 [mm]
01-1,1/2-122	41,0	115	70,0	86
01-1,1/2-123	46,0	115	78,0	86
01-1,1/2-124	50,0	135	81,0	86
01-1,1/2-125	55,0	140	86,0	86
01-1,1/2-126	60,0	150	94,0	86
01-1,1/2-127	65,0	150	100,0	86
01-1,1/2-128	70,0	160	105,0	86
01-1,1/2-129	75,0	170	110,0	86
01-1,1/2-130	80,0	170	116,0	86
01-1,1/2-131	85,0	170	125,0	86
01-1,1/2-132	90,0	175	128,0	86

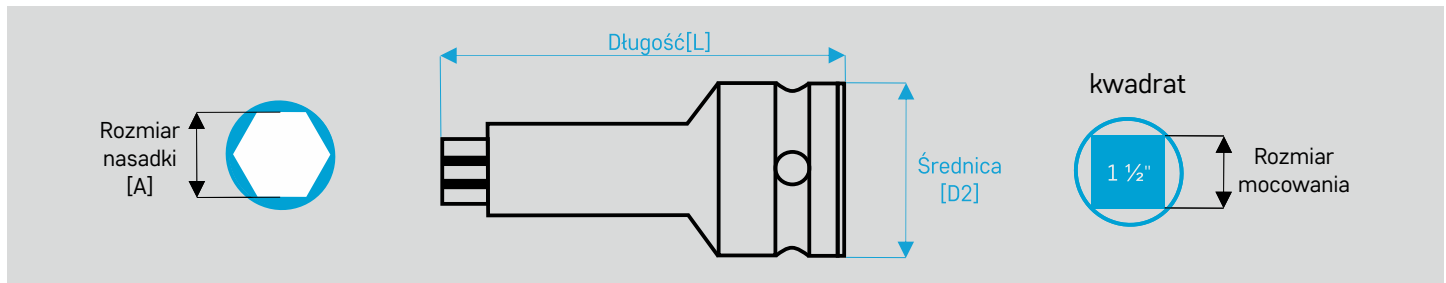

Nasadki wkrętakowe 6-kątne hexagon



Kod	A [mm]	L [mm]	D2 [mm]
01-1,1/2-153	19,0	105	86,0
01-1,1/2-154	22,0	105	86,0
01-1,1/2-155	24,0	105	86,0
01-1,1/2-156	27,0	105	86,0
01-1,1/2-157	30,0	105	86,0
01-1,1/2-158	32,0	105	86,0
01-1,1/2-159	36,0	105	86,0
01-1,1/2-160	41,0	105	86,0
01-1,1/2-161	46,0	105	86,0

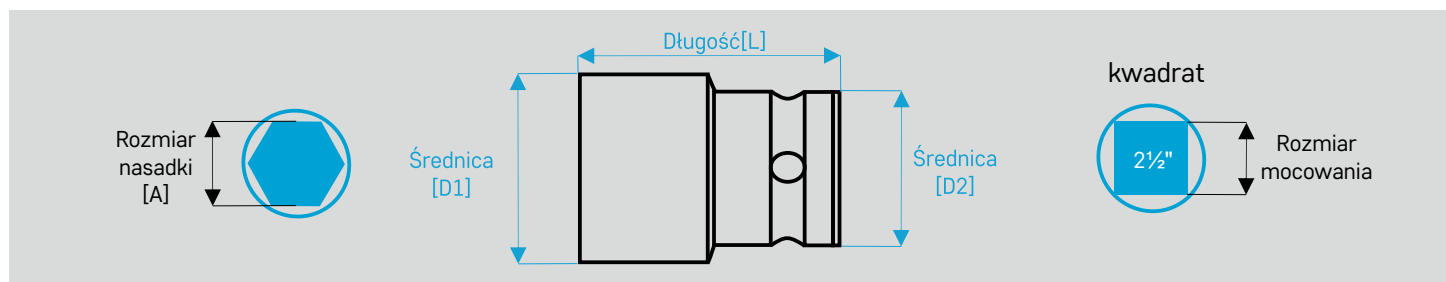

Nasadki udarowe 6-kątne hexagon



Kod	A [mm]	L [mm]	D1 [mm]	D2 [mm]
01-2,1/2-011	70,0	125	110,0	127
01-2,1/2-012	75,0	140	118,0	127
01-2,1/2-013	80,0	140	124,0	127
01-2,1/2-014	85,0	140	130,0	127
01-2,1/2-015	90,0	145	136,0	127
01-2,1/2-016	95,0	145	146,0	127
01-2,1/2-017	100,0	150	149,0	127
01-2,1/2-018	105,0	155	155,0	127
01-2,1/2-019	110,0	160	161,0	127
01-2,1/2-020	115,0	165	167,0	127
01-2,1/2-021	120,0	170	174,0	127
01-2,1/2-022	125,0	175	181,0	127
01-2,1/2-023	130,0	175	188,0	127
01-2,1/2-024	135,0	180	195,0	127
01-2,1/2-025	140,0	180	202,0	127
01-2,1/2-026	145,0	185	208,0	127
01-2,1/2-027	150,0	185	215,0	127
01-2,1/2-028	155,0	190	221,0	127
01-2,1/2-029	160,0	190	227,0	127
01-2,1/2-030	165,0	195	234,0	127
01-2,1/2-031	170,0	195	241,0	127
01-2,1/2-032	175,0	200	248,0	127
01-2,1/2-033	180,0	200	254,0	127

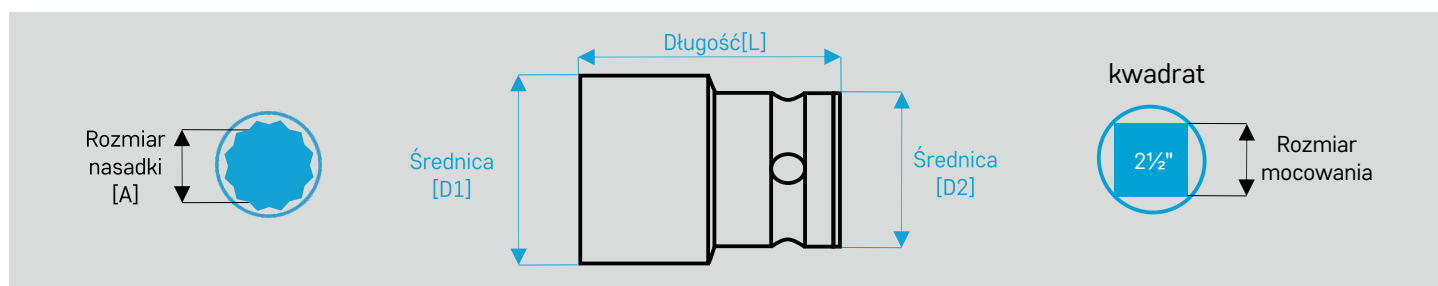

Nasadki udarowe
12-kątne double hexagon



Kod	A [mm]	L [mm]	D1 [mm]	D2 [mm]
01-2,1/2-054	70,0	125	110,0	127
01-2,1/2-055	75,0	140	118,0	127
01-2,1/2-056	80,0	140	124,0	127
01-2,1/2-057	85,0	140	130,0	127
01-2,1/2-058	90,0	145	136,0	127
01-2,1/2-059	95,0	145	146,0	127
01-2,1/2-060	100,0	150	149,0	127
01-2,1/2-061	105,0	155	155,0	127
01-2,1/2-062	110,0	160	161,0	127
01-2,1/2-063	115,0	165	167,0	127
01-2,1/2-064	120,0	170	174,0	127
01-2,1/2-065	125,0	175	181,0	127
01-2,1/2-066	130,0	175	188,0	127
01-2,1/2-067	135,0	180	195,0	127
01-2,1/2-068	140,0	180	202,0	127
01-2,1/2-069	145,0	185	208,0	127
01-2,1/2-070	150,0	185	215,0	127
01-2,1/2-071	155,0	190	221,0	127
01-2,1/2-072	160,0	190	227,0	127
01-2,1/2-073	165,0	195	234,0	127
01-2,1/2-074	170,0	195	241,0	127
01-2,1/2-075	175,0	200	248,0	127
01-2,1/2-076	180,0	200	254,0	127

**Klucze nasadowe zapewniają
szybkie i bezpieczniejsze mocowanie**

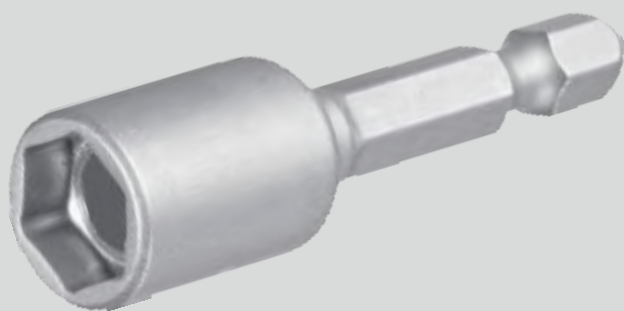

**Potrzebujesz indywidualnych rozwiązań?
Zapraszamy do kontaktu.**

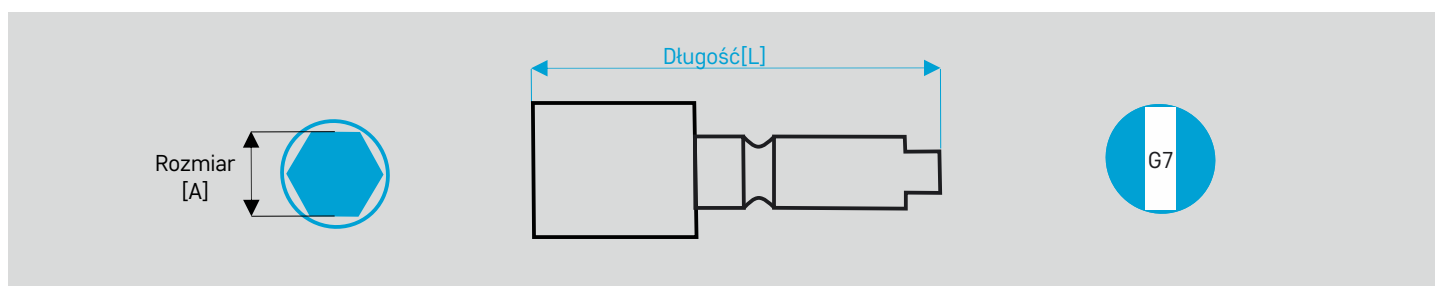

Klucz nasadowy 6-kątny hexagon

Kod	A [mm]	L [mm]
02-G7-011	8,0	50
02-G7-012	3/8"	50
02-G7-013	10,0	50
02-G7-014	13,0	50



Klucz nasadowy 6-kątny hexagon z magnesem

Kod	A [mm]	L [mm]
02-G7-035	8,0	50
02-G7-036	3/8"	50
02-G7-037	10,0	50
02-G7-038	13,0	50

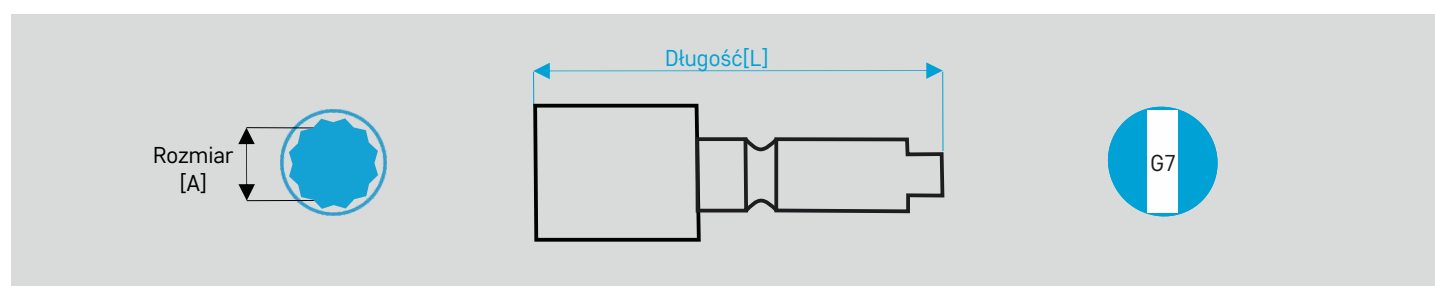

Klucz nasadowy 12-kątny double hexagon

Kod	A [mm]	L [mm]
02-G7-059	8,0	50
02-G7-060	3/8"	50
02-G7-061	10,0	50
02-G7-062	13,0	50



Klucz nasadowy 12-kątny double hexagon z magnesem

Kod	A [mm]	L [mm]
02-G7-083	8,0	50
02-G7-084	3/8"	50
02-G7-085	10,0	50
02-G7-086	13,0	50



Najlepsza precyzja w Twoich rękach

Zapewnij sobie niezawodność i dokładność w każdym zastosowaniu dzięki naszym kluczom nasadowym AWex. Wykonane z najwyższej jakości stali, nasze narzędzia są solidne, trwałe i gotowe sprostać najbardziej wymagającym zadaniom.

- >> **precyzja**, której możesz ufać
- >> **wytrzymałość** na wszystkie warunki
- >> **uniwersalne** zastosowanie
- >> **ergonomiczny design**

Nasza firma stawia na jakość i precyzję. Klucze nasadowe AWex to nie tylko narzędzia, to gwarancja efektywności i niezawodności.

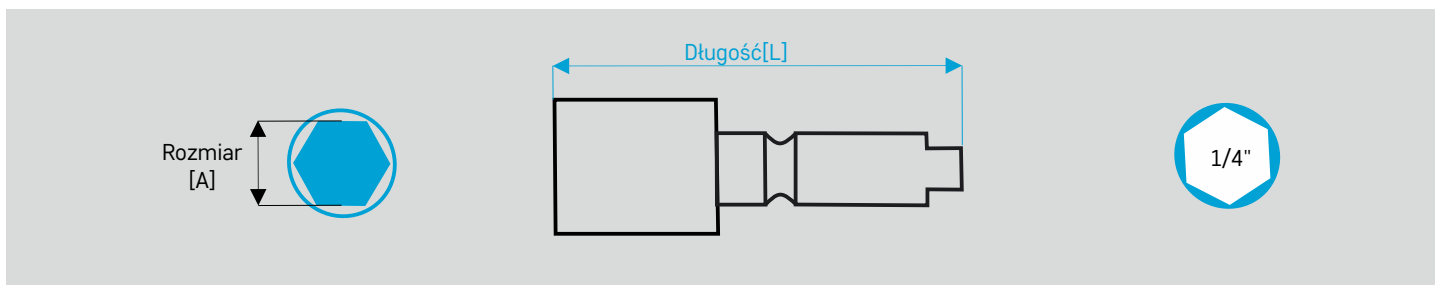

Klucz nasadowy 6-kątny hexagon



Kod	A [mm]	L [mm]
02-1/4-011	4,5	50
02-1/4-012	5,0	50
02-1/4-013	5,5	50
02-1/4-014	6,0	50
02-1/4-015	1/4"	50
02-1/4-016	7,0	50
02-1/4-017	8,0	50
02-1/4-018	9,0	50
02-1/4-019	3/8"	50
02-1/4-020	10,0	50
02-1/4-021	11,0	50
02-1/4-022	12,0	50
02-1/4-023	13,0	50
02-1/4-024	14,0	50

Klucz nasadowy 6-kątny hexagon z magnesem



Kod	A [mm]	L [mm]
02-1/4-045	4,5	50
02-1/4-046	5,0	50
02-1/4-047	5,5	50
02-1/4-048	6,0	50
02-1/4-049	1/4"	50
02-1/4-050	7,0	50
02-1/4-051	8,0	50
02-1/4-052	9,0	50
02-1/4-053	3/8"	50
02-1/4-054	10,0	50
02-1/4-055	11,0	50
02-1/4-056	12,0	50
02-1/4-057	13,0	50

Klucz nasadowy 6-kątny hexagon - dłuższa wersja



Kod	A [mm]	L [mm]
02-1/4-078	4,5	65
02-1/4-079	5,0	65
02-1/4-080	5,5	65
02-1/4-081	6,0	65
02-1/4-082	1/4"	65
02-1/4-083	7,0	65
02-1/4-084	8,0	65
02-1/4-085	9,0	65
02-1/4-086	3/8"	65
02-1/4-087	10,0	65
02-1/4-088	13,0	65

Klucz nasadowy 6-kątny hexagon - dłuższa wersja z magnesem



Kod	A [mm]	L [mm]
02-1/4-119	5,5	65
02-1/4-120	6,0	65
02-1/4-121	7,0	65
02-1/4-122	8,0	65
02-1/4-123	3/8"	65
02-1/4-124	10,0	65
02-1/4-125	13,0	65



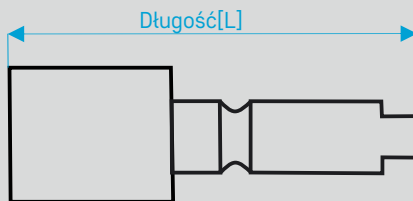
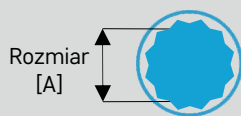

Klucz nasadowy 12-kątny double hexagon



Kod	A [mm]	L [mm]
02-1/4-146	4,5	50
02-1/4-147	5,0	50
02-1/4-148	5,5	50
02-1/4-149	6,0	50
02-1/4-150	1/4"	50
02-1/4-151	7,0	50
02-1/4-152	8,0	50
02-1/4-153	9,0	50
02-1/4-154	3/8"	50
02-1/4-155	10,0	50
02-1/4-156	11,0	50
02-1/4-157	12,0	50
02-1/4-158	13,0	50
02-1/4-159	14,0	50

Klucz nasadowy 12-kątny double hexagon z magnesem



Kod	A [mm]	L [mm]
02-1/4-180	4,5	50
02-1/4-181	5,0	50
02-1/4-182	5,5	50
02-1/4-183	6,0	50
02-1/4-184	1/4"	50
02-1/4-185	7,0	50
02-1/4-186	8,0	50
02-1/4-187	9,0	50
02-1/4-188	3/8"	50
02-1/4-189	10,0	50
02-1/4-190	11,0	50
02-1/4-191	12,0	50
02-1/4-192	13,0	50

Klucz nasadowy 12-kątny double hexagon - dłuższa wersja



Kod	A [mm]	L [mm]
02-1/4-213	4,5	65
02-1/4-214	5,0	65
02-1/4-215	5,5	65
02-1/4-216	6,0	65
02-1/4-217	1/4"	65
02-1/4-218	7,0	65
02-1/4-219	8,0	65
02-1/4-220	9,0	65
02-1/4-221	3/8"	65
02-1/4-222	10,0	65
02-1/4-223	13,0	65

Klucz nasadowy 12-kątny double hexagon - dłuższa wersja z magnesem



Kod	A [mm]	L [mm]
02-1/4-244	5,5	65
02-1/4-245	6,0	65
02-1/4-246	7,0	65
02-1/4-247	8,0	65
02-1/4-248	3/8"	65
02-1/4-249	10,0	65
02-1/4-250	13,0	65

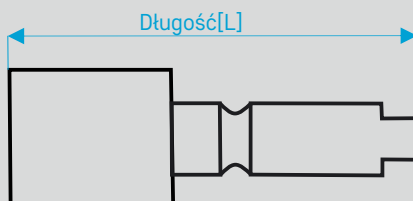

Klucz nasadowy TORX®



Kod	A [mm]	L [mm]
02-1/4-271	E4	50
02-1/4-272	E5	50
02-1/4-273	E6	50
02-1/4-274	E8	50
02-1/4-275	E10	50

Łączniki i przedłużki do kluczy nasadowych zapewniają uniwersalność, wielofunkcyjność oraz lepszy zasięg Twoich narzędzi

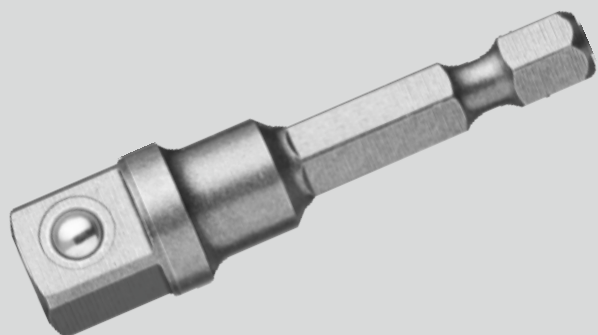

Potrzebujesz indywidualnych rozwiązań?
Zapraszamy do kontaktu.



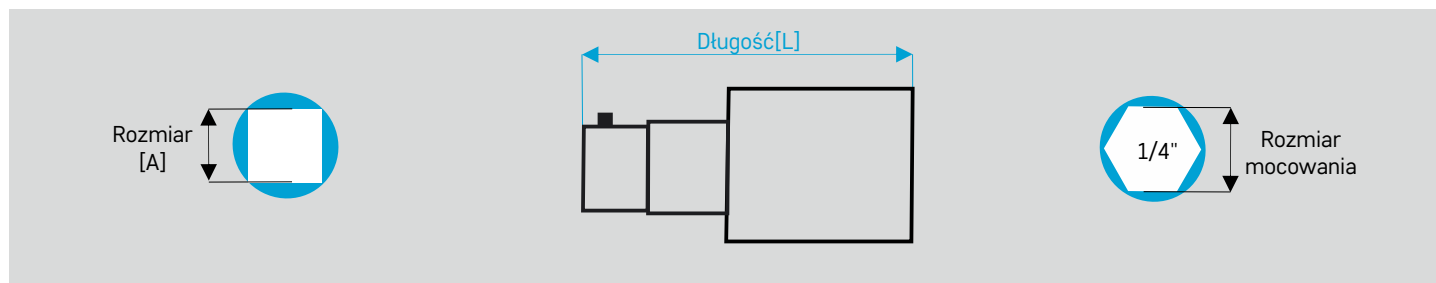

Łącznik do klucza z kątkiem sprężynowym



Kod	A [mm]	L [mm]
03-1/4-011	1/4"	25
03-1/4-012	3/8"	30

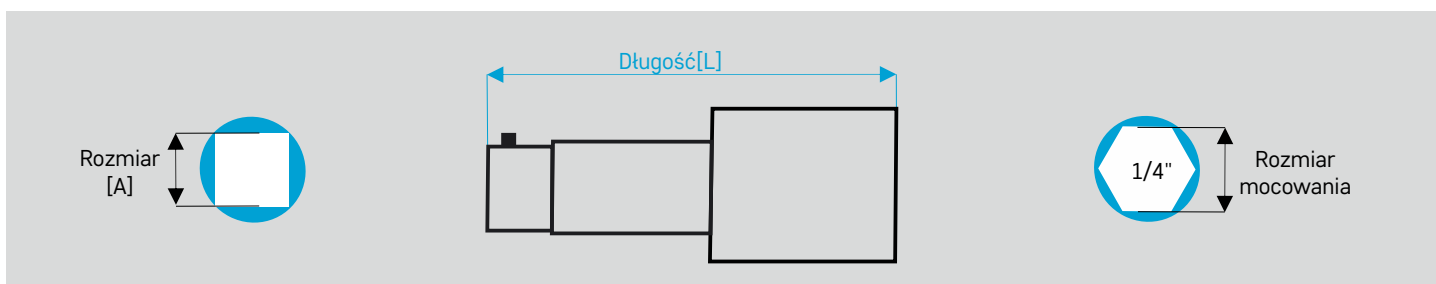

Łącznik do klucza z kątkiem sprężynowym



Kod	A [mm]	L [mm]
03-1/4-033	1/4"	50
03-1/4-034	1/4"	75
03-1/4-035	1/4"	102
03-1/4-036	1/4"	150
03-1/4-037	1/4"	200
03-1/4-038	1/4"	250
03-1/4-039	3/8"	50
03-1/4-040	3/8"	75
03-1/4-041	3/8"	102
03-1/4-042	3/8"	152
03-1/4-043	1/4"	200
03-1/4-044	1/4"	250
03-1/4-045	1/2"	50

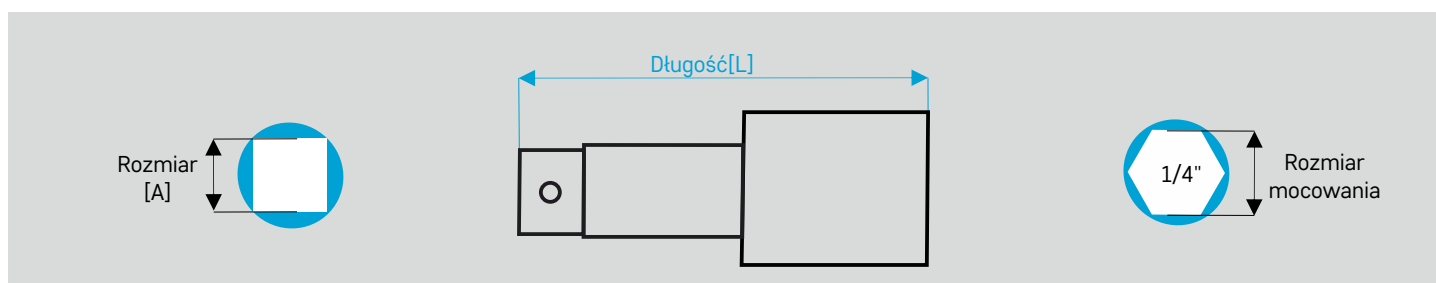

Łącznik do klucza z otworem przelotowym



Kod	A [mm]	L [mm]
03-1/4-066	1/4"	50
03-1/4-067	1/4"	75
03-1/4-068	1/4"	200
03-1/4-069	3/8"	75

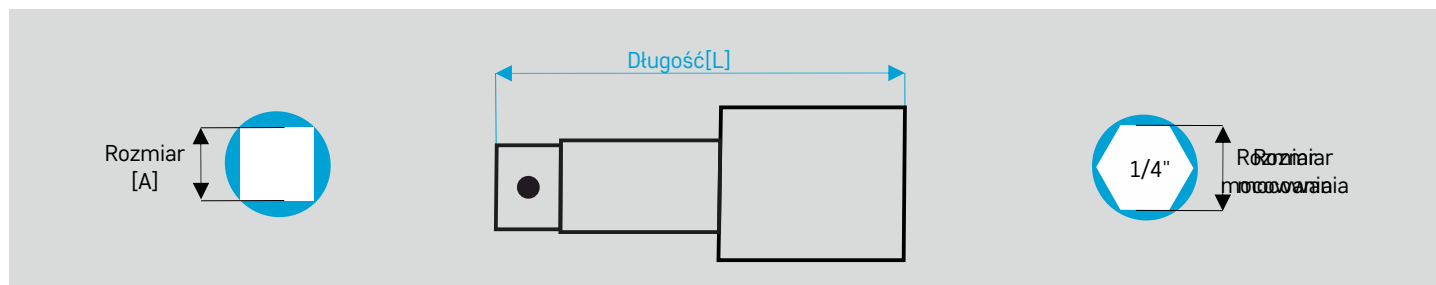

Łącznik do klucza z kulką



Kod	A [mm]	L [mm]
03-1/4-090	1/4"	75
03-1/4-091	3/8"	200
02-1/4-092	1/2"	50

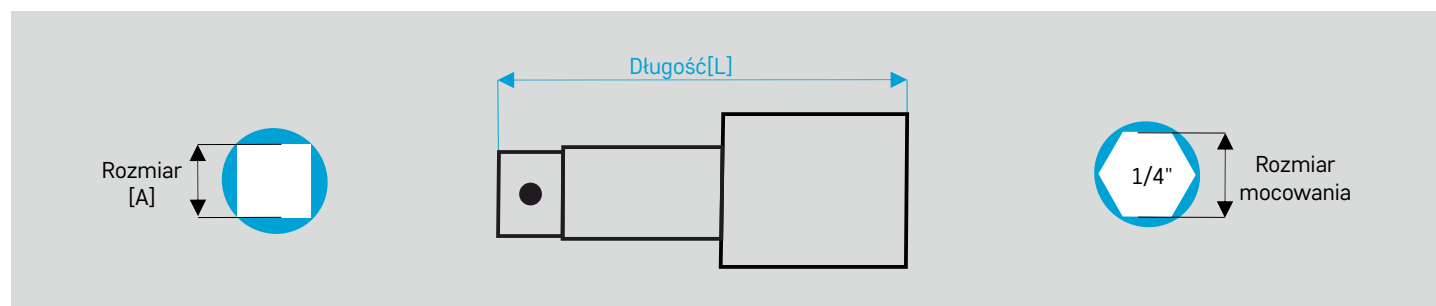

Łącznik do klucza z szybkozłączką, z kulką



Kod	A [mm]	L [mm]
03-1/4-113	1/4"	60
03-1/4-114	3/8"	75
03-1/4-115	1/2"	75

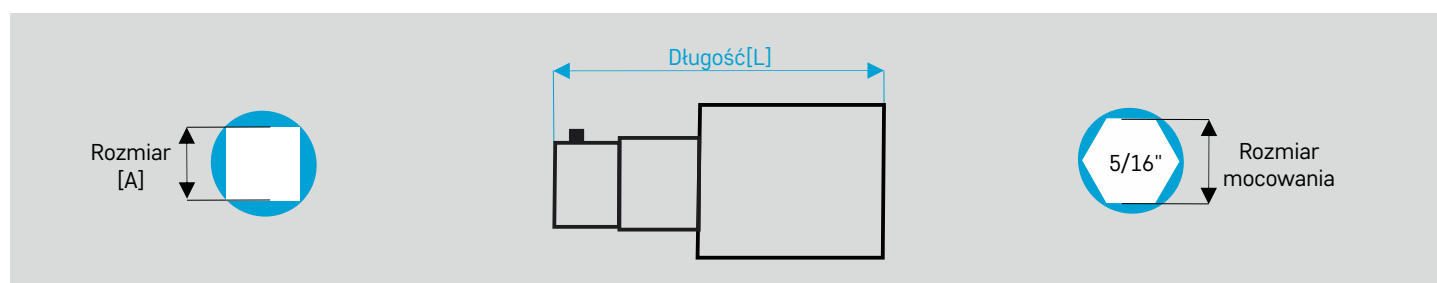

Łącznik do klucza z kątkiem sprężynowym



Kod	A [mm]	L [mm]
03-5/16-011	1/4"	40
03-5/16-012	3/8"	40

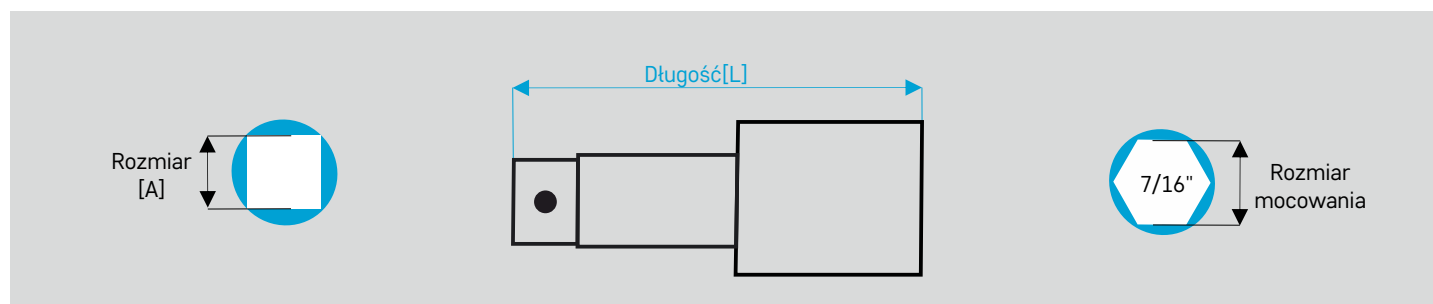

Łącznik do klucza z szybkozłączką, z kulką



Kod	A [mm]	L [mm]
03-7/16-011	3/8"	75
03-7/16-012	1/2"	75

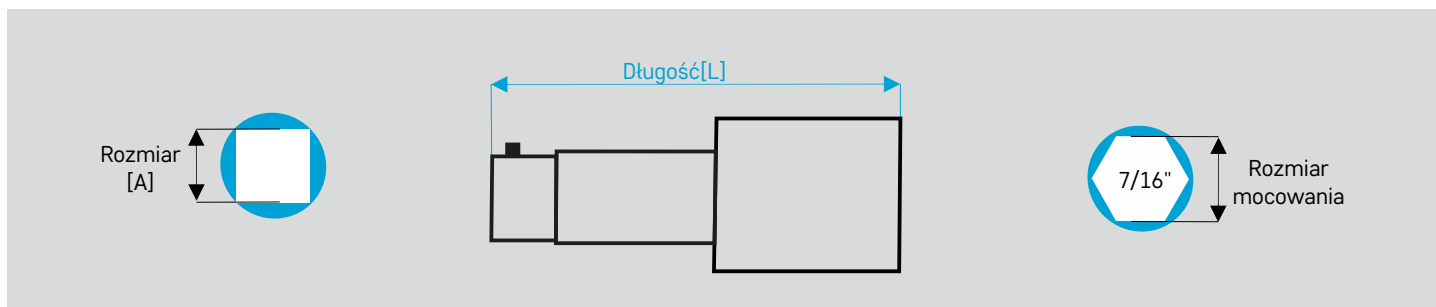

Łącznik do klucza z kołkiem sprężynowym



Kod	A [mm]	L [mm]
03-7/16-033	1/4"	50
03-7/16-034	3/8"	75
03-7/16-035	3/8"	125
03-7/16-036	3/8"	200
03-7/16-037	1/2"	70
03-7/16-038	1/2"	125
03-7/16-039	1/2"	200

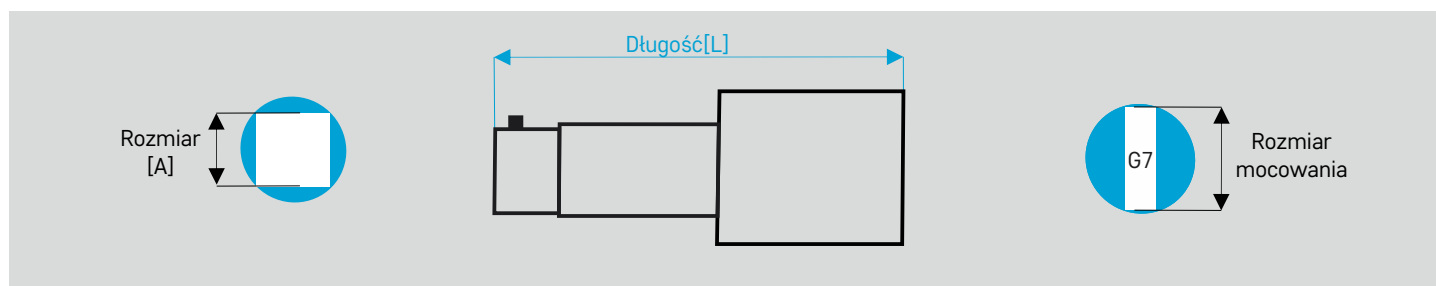

Łącznik do klucza z kołkiem sprężynowym



Kod	A [mm]	L [mm]
03-G7-011	1/4"	50
03-G7-012	1/4"	100

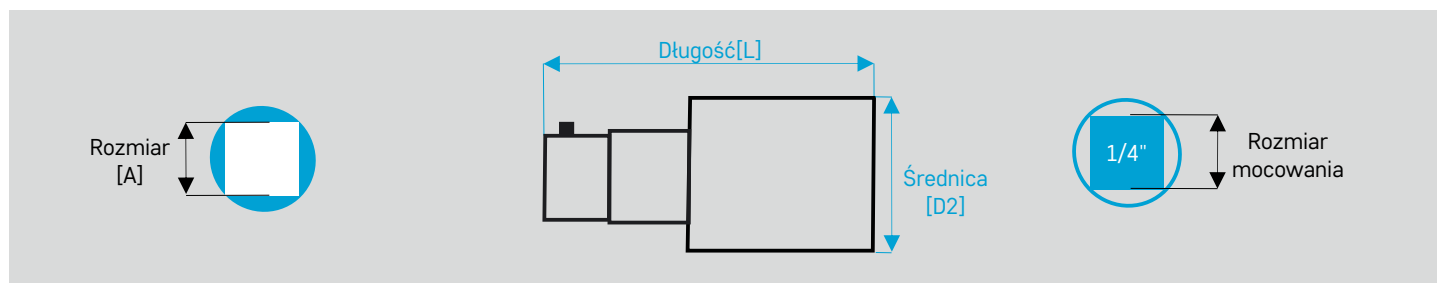

Łącznik do klucza z kołkiem sprężynowym



Kod	A [mm]	L [mm]	D2 [mm]
03-1/4-136	3/8"	26	13,0

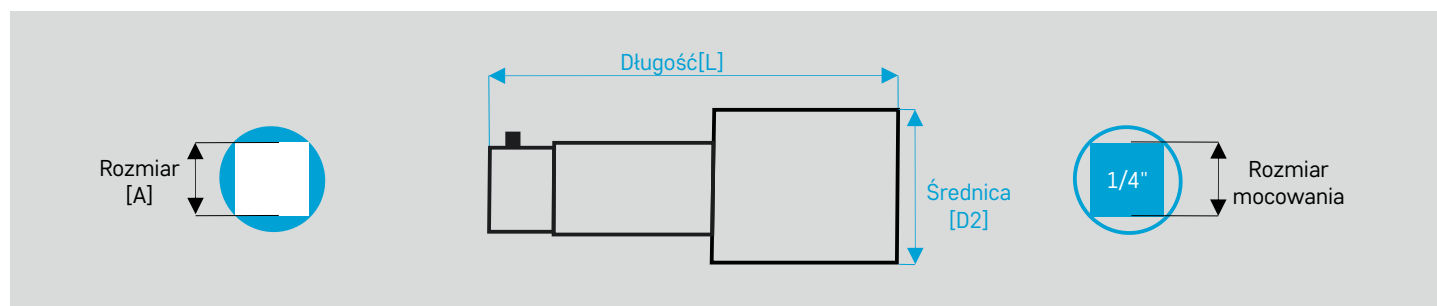

Przedłużka do klucza z kołkiem sprężynowym



Kod	A [mm]	L [mm]	D2 [mm]
03-1/4-157	1/4"	50	13
03-1/4-158	1/4"	150	13
03-1/4-159	1/4"	200	13

Potrzebujesz czegoś więcej? Dla nas to żaden problem!

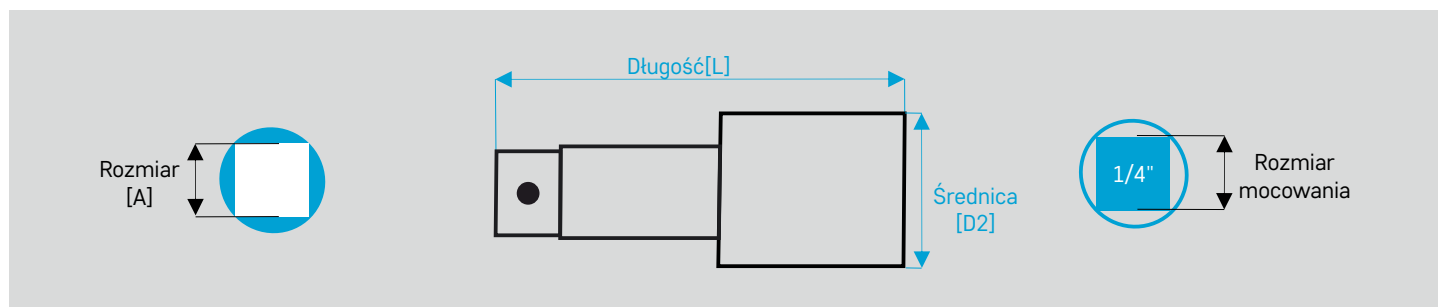

Przedłużka do klucza z kulką



Kod	A [mm]	L [mm]	D2 [mm]
03-1/4-180	1/4"	50	13

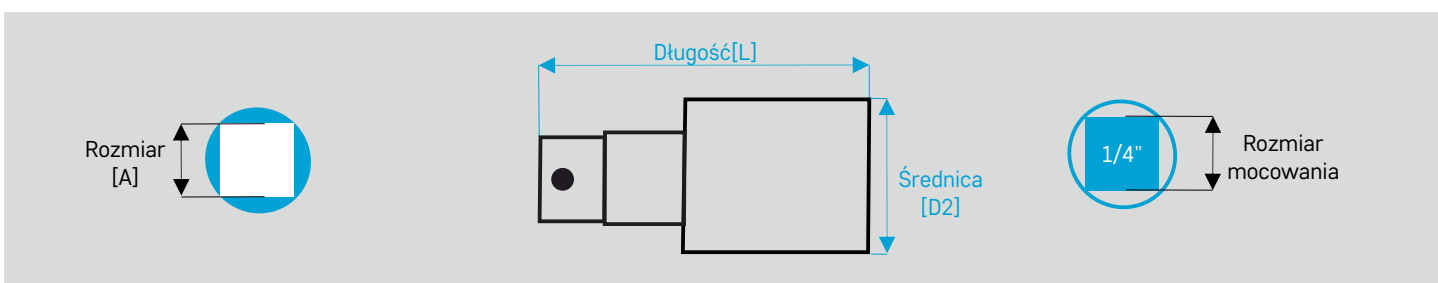

Łącznik do klucza z szybkozłączką, z kulką



Kod	A [mm]	L [mm]	D2 [mm]
03-1/4-201	1/4"	35	13

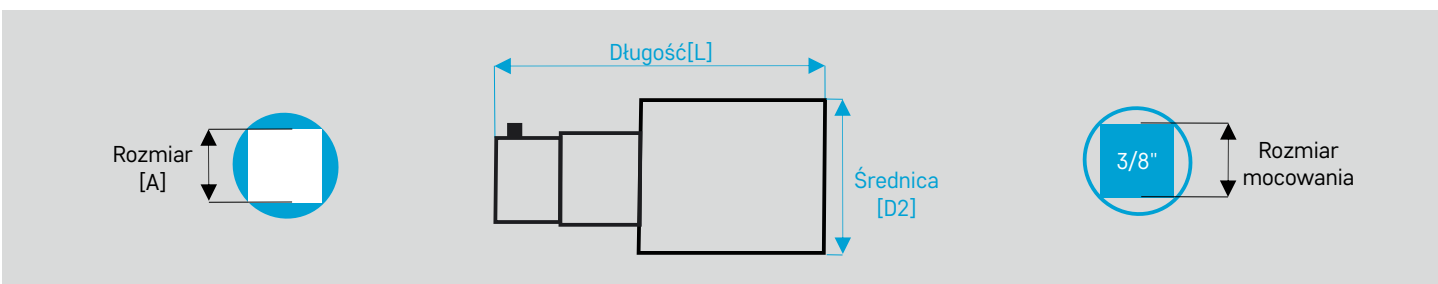

Łącznik do klucza z kotkiem sprężynowym



Kod	A [mm]	L [mm]	D2 [mm]
03-3/8-011	1/4"	32	19,0
03-3/8-012	1/2"	36	22,0

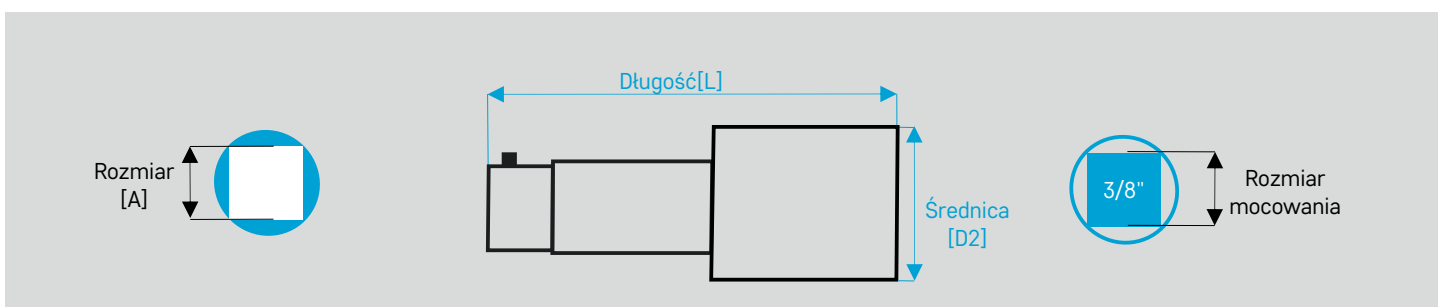

Przedłużka do klucza z kotkiem sprężynowym



Kod	A [mm]	L [mm]	D2 [mm]
03-3/8-033	3/8"	50	19,0
03-3/8-034	3/8"	75	19,0
03-3/8-035	3/8"	150	19,0
03-3/8-036	3/8"	200	22,0
03-3/8-037	3/8"	300	22,0

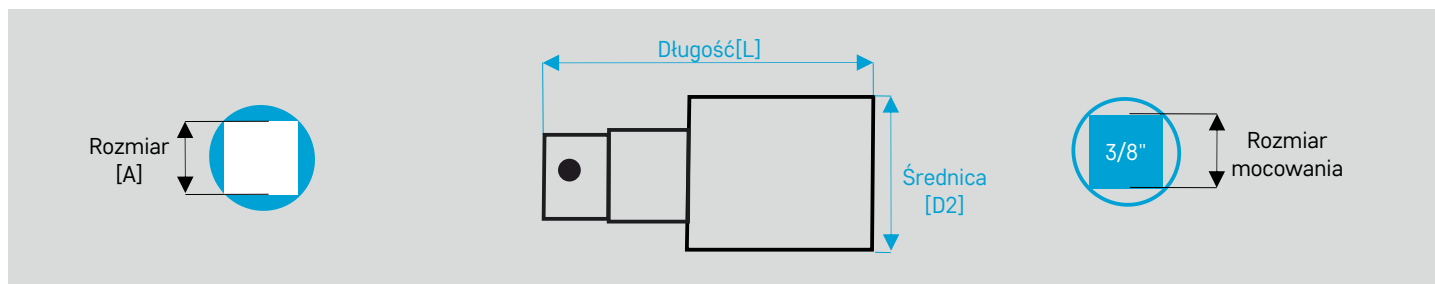

Przedłużka do klucza z kulą



Kod	A [mm]	L [mm]	D2 [mm]
03-3/8-058	3/8"	50	19
03-3/8-059	3/8"	75	19
03-3/8-060	3/8"	150	19

Łącznik do klucza z szybkozłączką, z kulą



Kod	A [mm]	L [mm]	D2 [mm]
03-3/8-089	3/8"	46	20

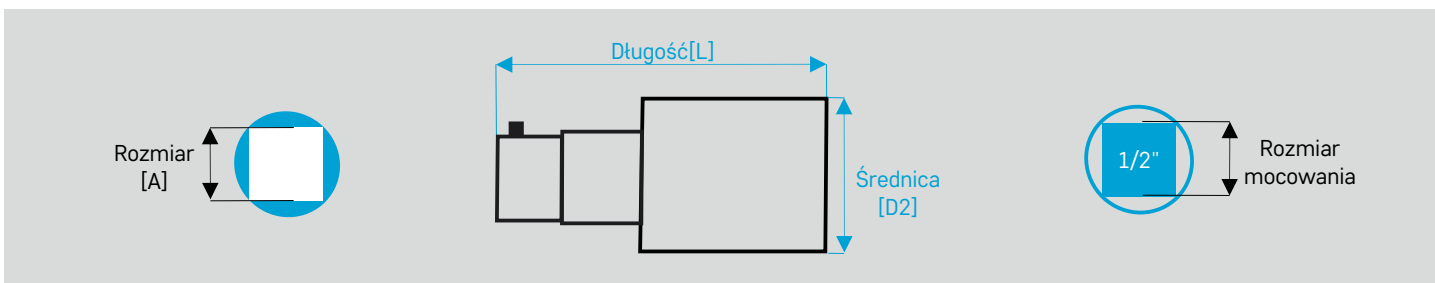

Łącznik do klucza z kotłkiem sprężynowym



Kod	A [mm]	L [mm]	D2 [mm]
03-1/2-011	1/4"	25	19,0
03-1/2-012	3/8"	25	22,0

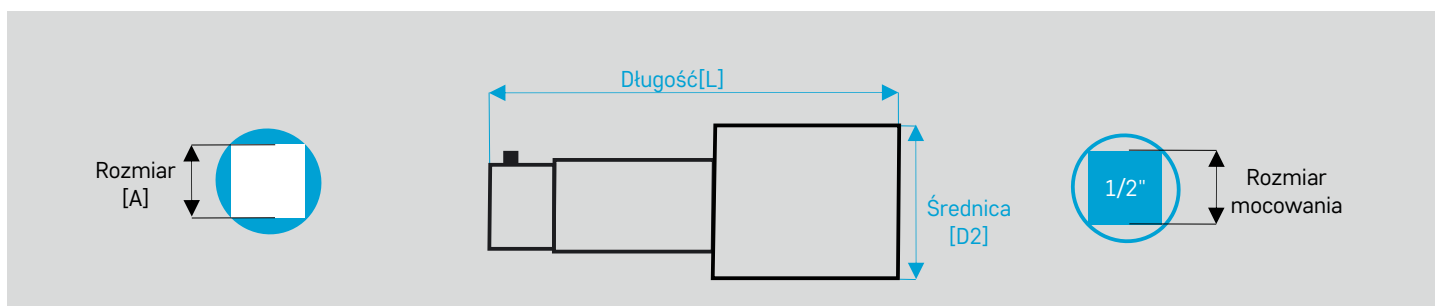

Przedłużka do klucza z kotłkiem sprężynowym



Kod	A [mm]	L [mm]	D2 [mm]
03-1/2-133	1/2"	50	25,0
03-1/2-134	1/2"	75	25,0
03-1/2-135	1/2"	125	25,0
03-1/2-136	1/2"	150	25,0
03-1/2-137	1/2"	175	25,0
03-1/2-138	1/2"	250	25,0



Potrzebujesz czegoś więcej? Dla nas to żaden problem!

48 Możemy wyprodukować narzędzia specjalne dostosowane do Twoich indywidualnych potrzeb.

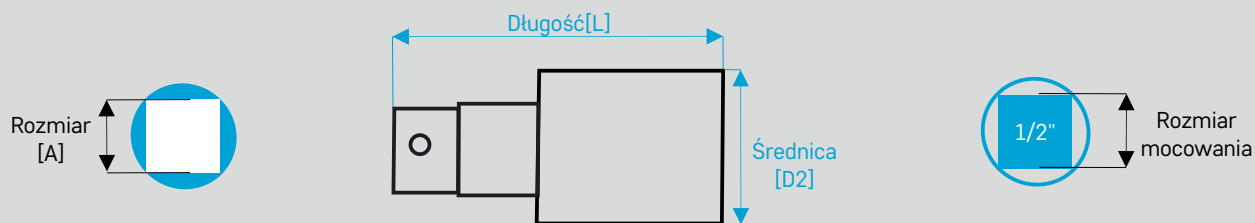

Łącznik do klucza z otworem przelotowym



Kod	A [mm]	L [mm]	D2 [mm]
03-1/2-159	3/4"	48	30,0

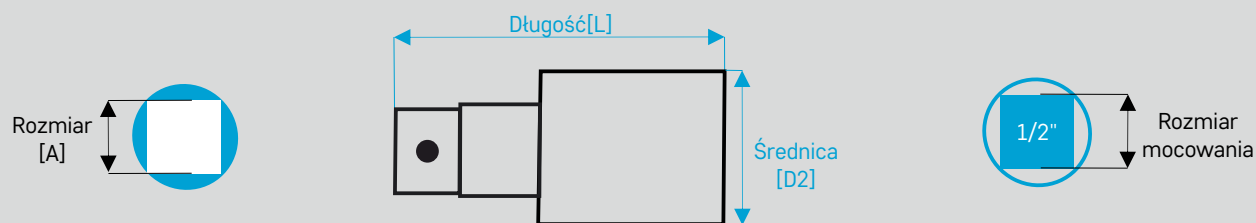

Łącznik do klucza z szybkołączką, z kulką



Kod	A [mm]	L [mm]	D2 [mm]
03-1/2-180	1/2"	60	25

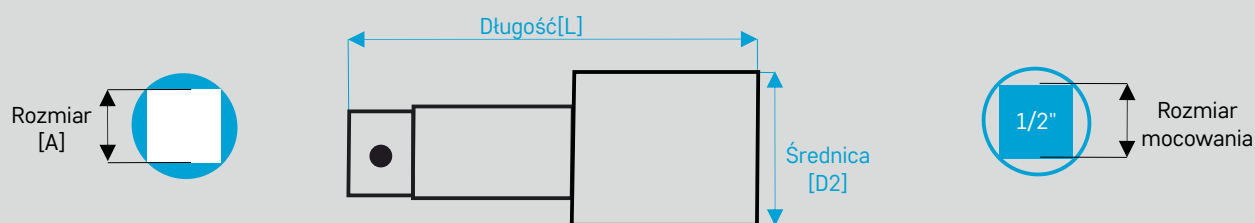

Przedłużka do klucza z kulką



Kod	A [mm]	L [mm]	D2 [mm]
03-1/2-201	1/2"	75	25
03-1/2-202	1/2"	125	25
03-1/2-203	1/2"	150	25

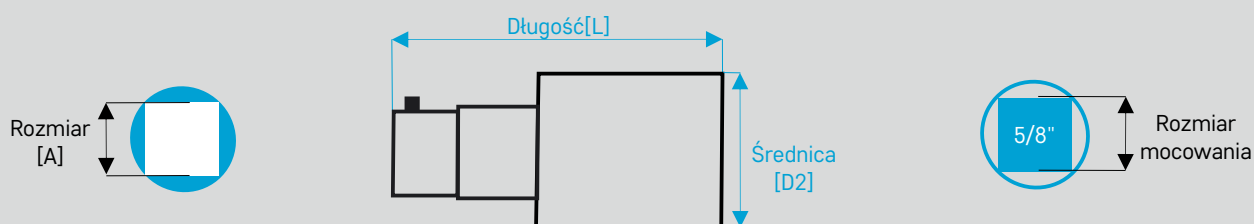

Łącznik do klucza z kotkiem sprężynowym



Kod	A [mm]	L [mm]	D2 [mm]
03-5/8-011	1/2"	46	35,0

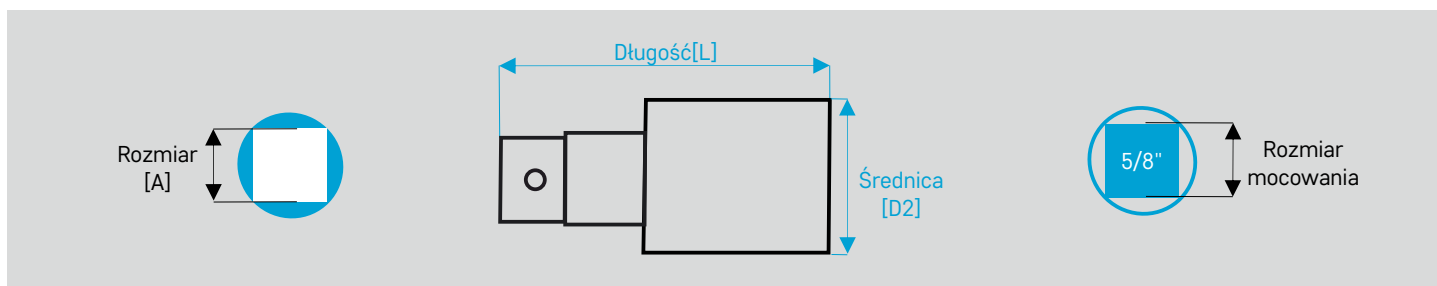

Łącznik do klucza z otworem przelotowym



Kod	A [mm]	L [mm]	D2 [mm]
03-5/8-032	3/4"	70	35,0

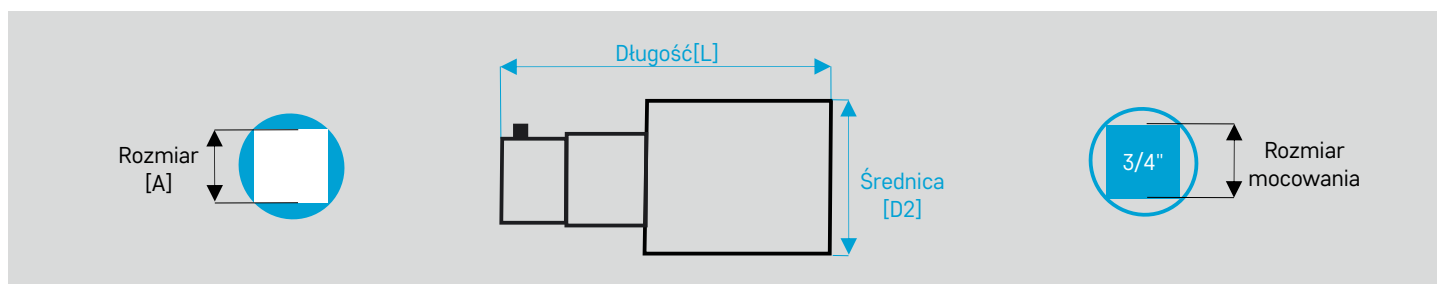

Łącznik do klucza z kołkiem sprężynowym



Kod	A [mm]	L [mm]	D2 [mm]
03-3/4-011	1/2"	57	44,0

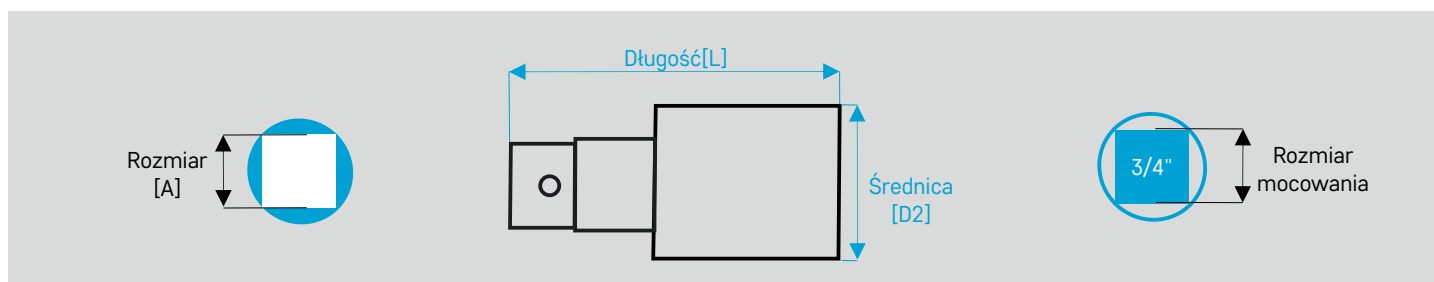

Łącznik do klucza z otworem przelotowym



Kod	A [mm]	L [mm]	D2 [mm]
03-3/4-033	1"	63	44,0

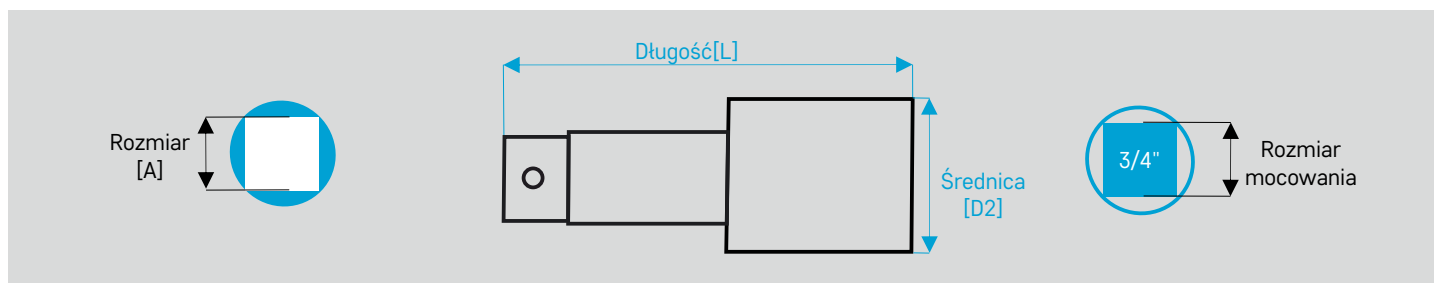

Przedłużka do klucza z otworem przelotowym



Kod	A [mm]	L [mm]	D2 [mm]
03-3/4-054	3/4"	175	44,0
03-3/4-055	3/4"	250	44,0
03-3/4-056	3/4"	330	44,0

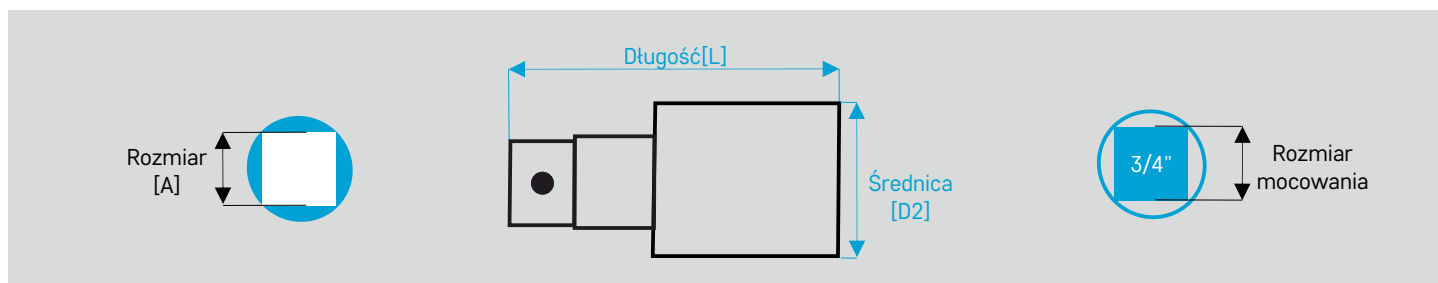

Łącznik do klucza z szybkołączką, z kulką



Kod	A [mm]	L [mm]	D2 [mm]
03-3/4-077	3/4"	78	44

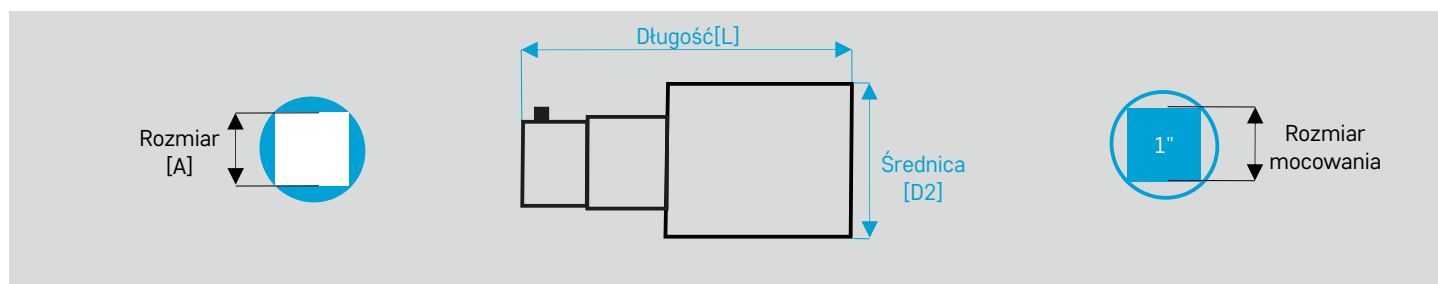

Łącznik do klucza z kotkiem sprężynowym



Kod	A [mm]	L [mm]	D2 [mm]
03-1-011	1/2"	95	86,0

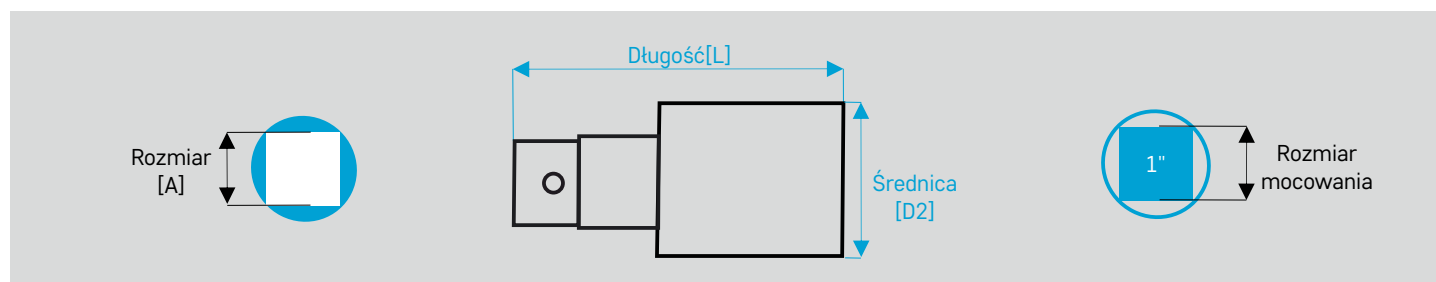

Łącznik do klucza z otworem przelotowym



Kod	A [mm]	L [mm]	D2 [mm]
03-1-032	3/4"	75	54,0
03-1-033	1 1/2"	91	54,0

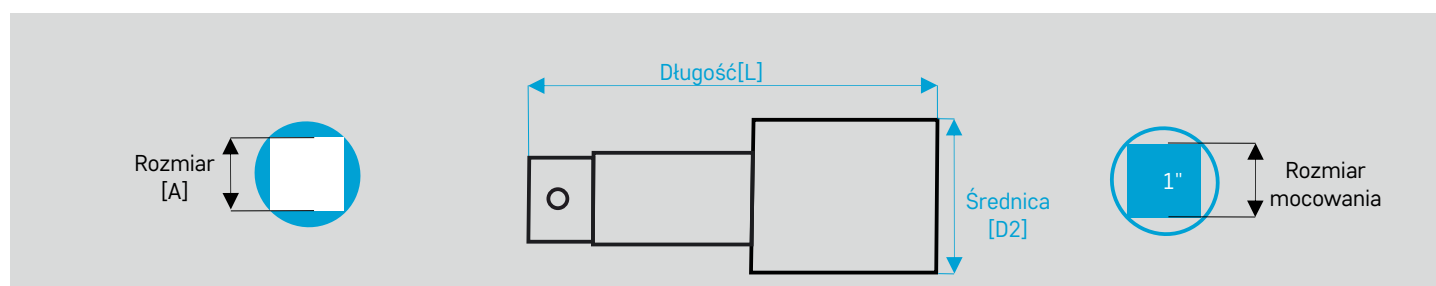

Przedłużka do klucza z otworem przelotowym



Kod	A [mm]	L [mm]	D2 [mm]
03-1-054	1"	175	54,0
03-1-055	1"	250	54,0
03-1-056	1"	330	54,0

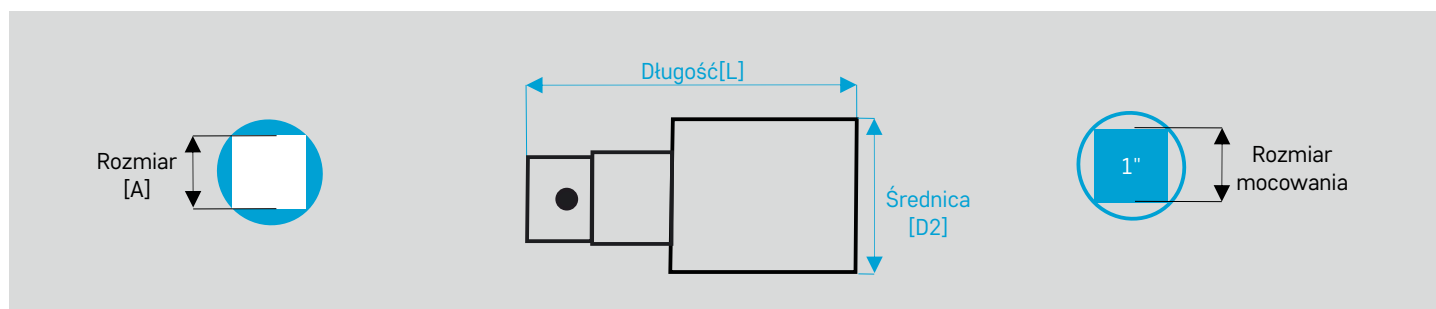

Łącznik do klucza z szybkozłączką, z kulką



Kod	A [mm]	L [mm]	D2 [mm]
03-1-077	1"	96	54

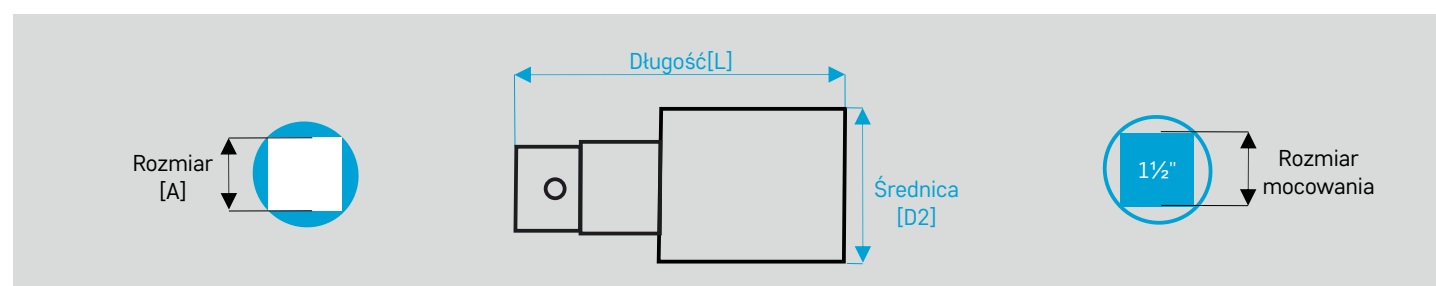

Łącznik do klucza z otworem przelotowym



Kod	A [mm]	L [mm]	D2 [mm]
03-1,1/2-011	1"	95	86,0
03-1,1/2-012	2 1/2"	120	86,0

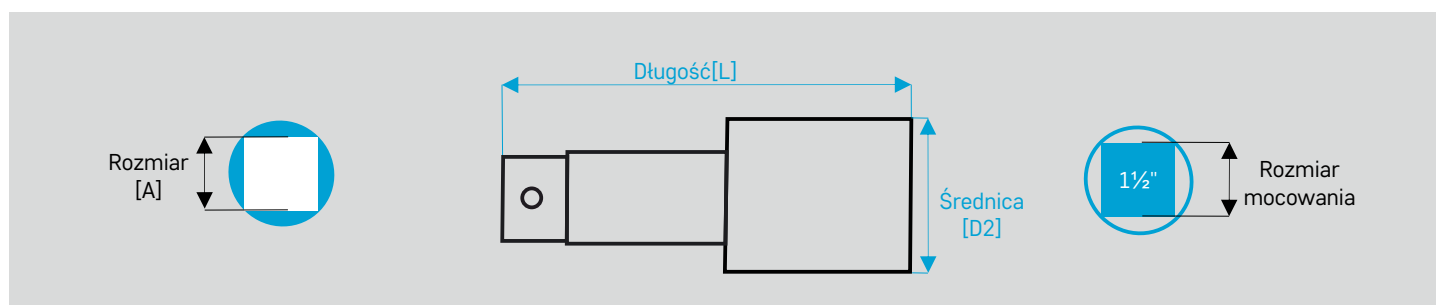

Przedłużka do klucza z otworem przelotowym



Kod	A [mm]	L [mm]	D2 [mm]
03-1,1/2-032	1 1/2"	125	86,0
03-1,1/2-033	1 1/2"	250	86,0
03-1,1/2-034	1 1/2"	500	86,0

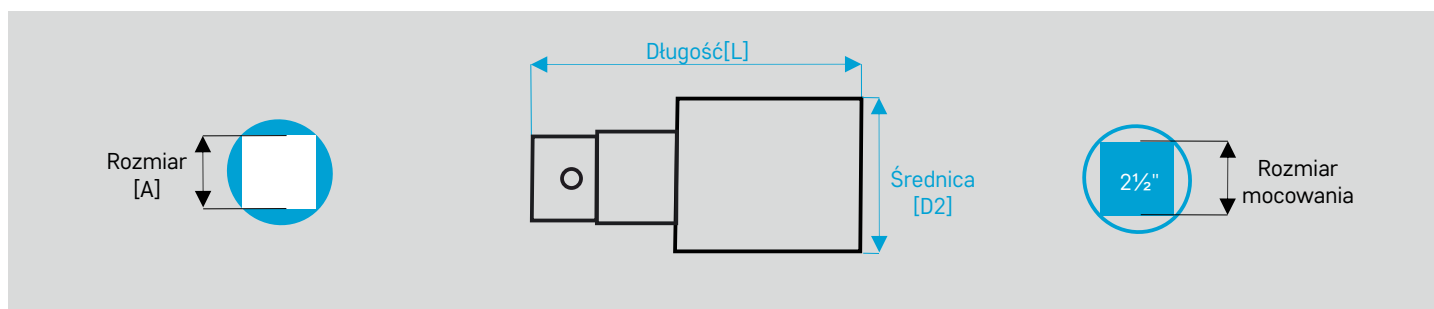

Łącznik do klucza
z otworem przelotowym



Kod	A [mm]	L [mm]	D2 [mm]
03-2,1/2-011	1 1/2"	138	127,0

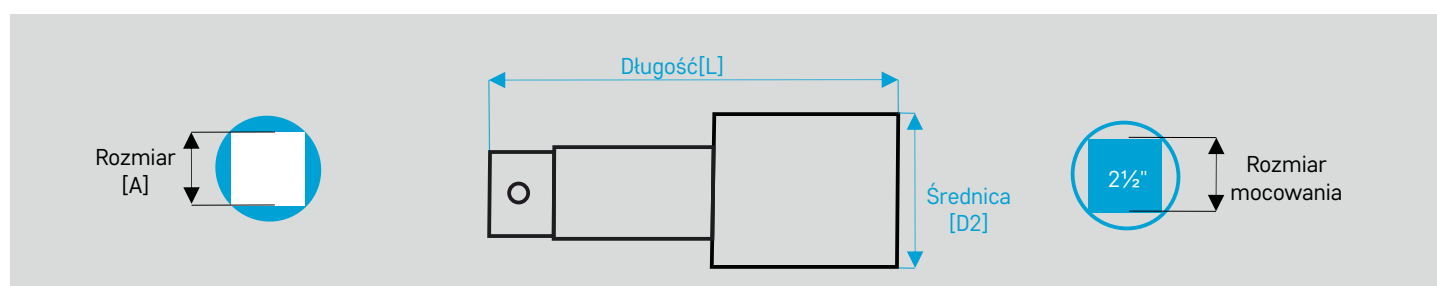

Przedłużka do klucza
z otworem przelotowym



Kod	A [mm]	L [mm]	D2 [mm]
03-2,1/2-032	2 1/2"	250	127,0
03-2,1/2-033	2 1/2"	500	127,0

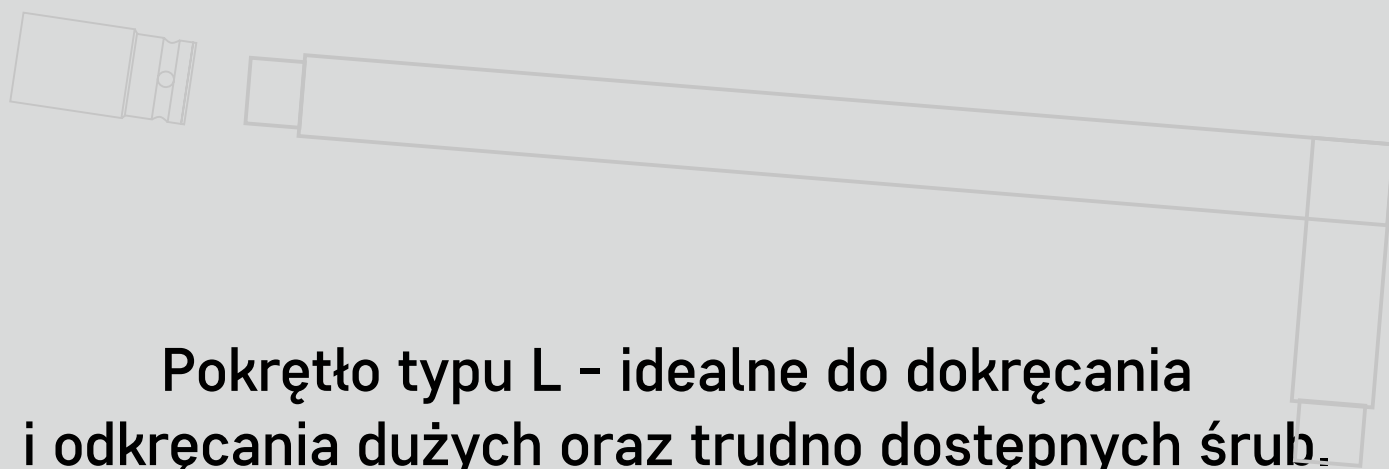

Pokrętło typu L - idealne do dokręcania i odkręcania dużych oraz trudno dostępnych śrub.

Wyjątkowo funkcjonalne narzędzie, niezbędne w każdym warsztacie i podczas prac serwisowych.

Ergonomiczny design oraz solidna konstrukcja gwarantują łatwość obsługi i skuteczność w różnorodnych zadaniach. Niezbędne wsparcie podczas prac naprawczych i konserwacyjnych.

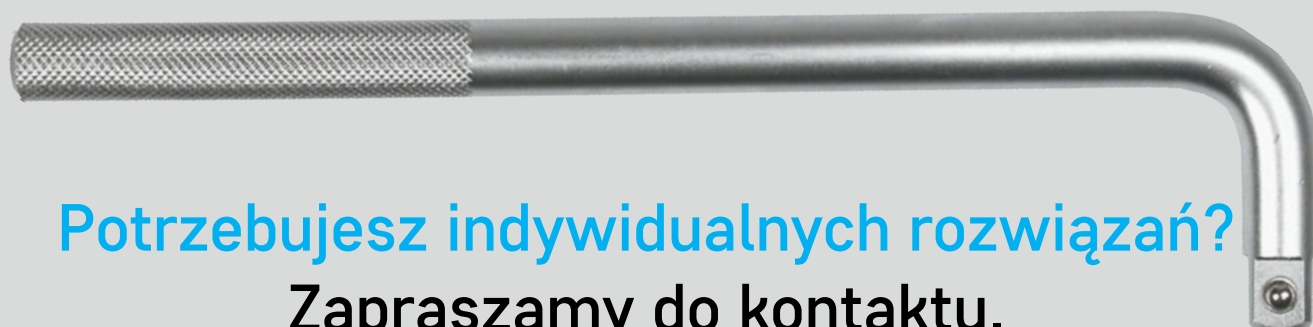

Potrzebujesz indywidualnych rozwiązań?
Zapraszamy do kontaktu.

04 Pokrętła typ L

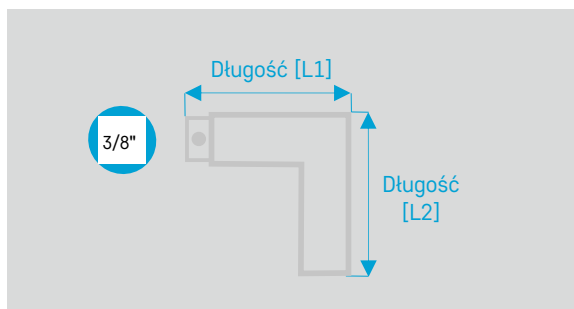

Pokrętło 3/8 "

Kod	L1 [mm]	L2 [mm]
04-3/8-011	300	300

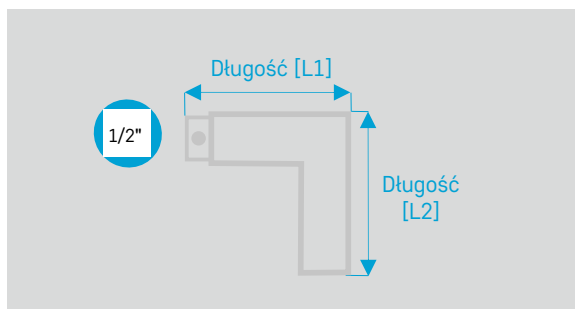

Pokrętło 1/2"

Kod	L1 [mm]	L2 [mm]
04-1/2-011	300	300

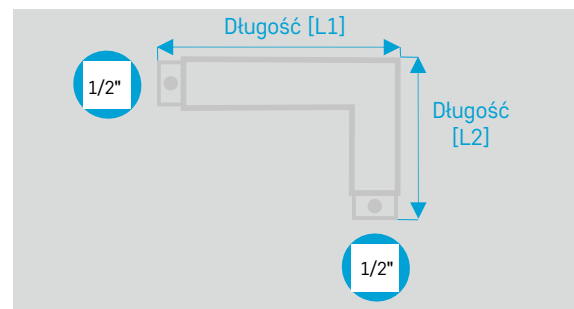

Pokrętło 1/2"

Kod	L1 [mm]	L2 [mm]
04-1/2-021	240	50
04-1/2-022	400	70

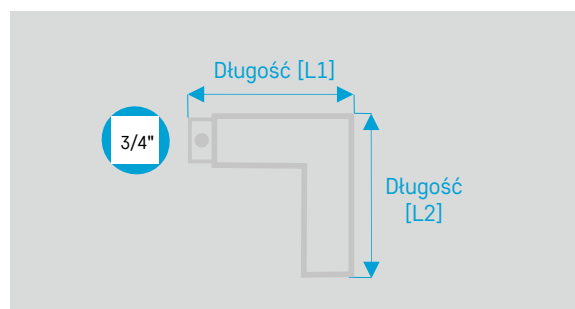

Pokrętło 3/4"

Kod	L1 [mm]	L2 [mm]
04-3/4-011	300	300

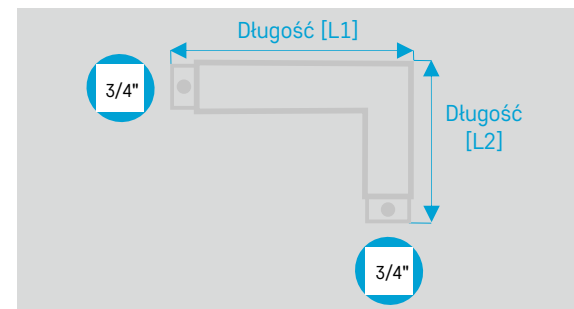

Pokrętło 3/4"

Kod	L1 [mm]	L2 [mm]
04-3/4-021	470	100
04-3/4-022	490	260

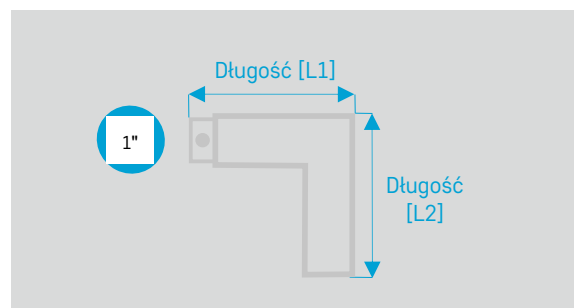

Pokrętło 1"

Kod	L1 [mm]	L2 [mm]
04-1-011	300	300

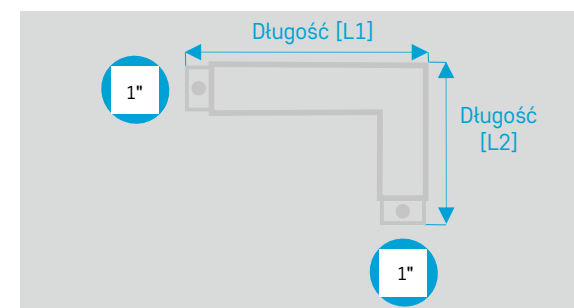

Pokrętło 1"

Kod	L1 [mm]	L2 [mm]
04-1-021	520	110

Potrzebujesz czegoś więcej? Dla nas to żaden problem!

Możemy wyprodukować narzędzia specjalne dostosowane do Twoich indywidualnych potrzeb.



Krzysztof Hetnał

☎ 518 275 934
✉ k.hetnal@narzedzia-bielsko.pl

Bartłomiej Niesyt

☎ 571 316 091
✉ b.niesyt@narzedzia-bielsko.pl

Adam Bucki

☎ 512 578 797
✉ a.bucki@narzedzia-bielsko.pl

25 lat



ul. Żywiecka 45, 43-300 Bielsko-Biała
☎ +48 33 812 42 90
✉ technika@narzedzia-bielsko.pl